

**STIHL**<sup>®</sup>

## Путеводитель по цепям

Цепи STIHL для всех моторных пил  
Шины STIHL

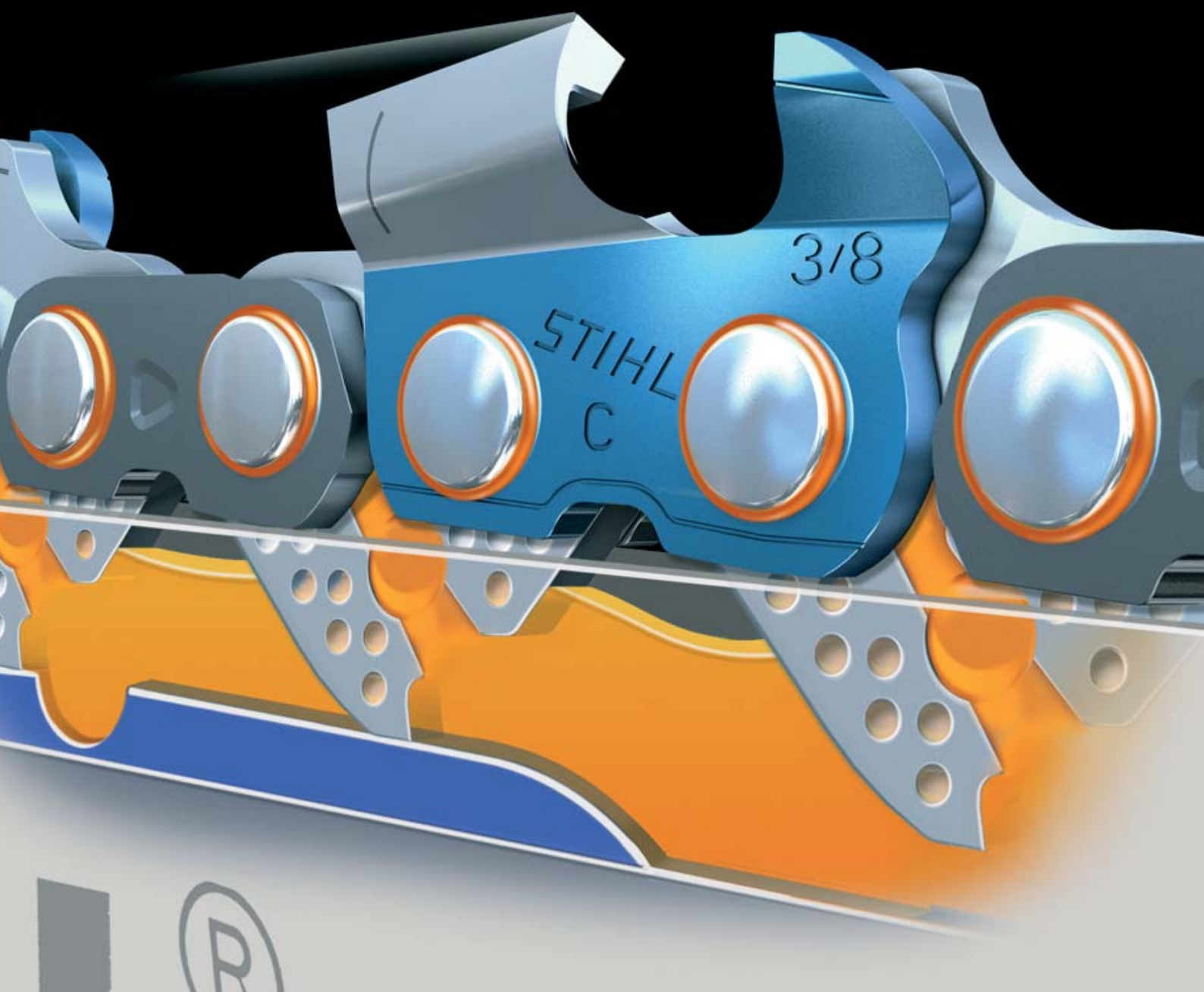

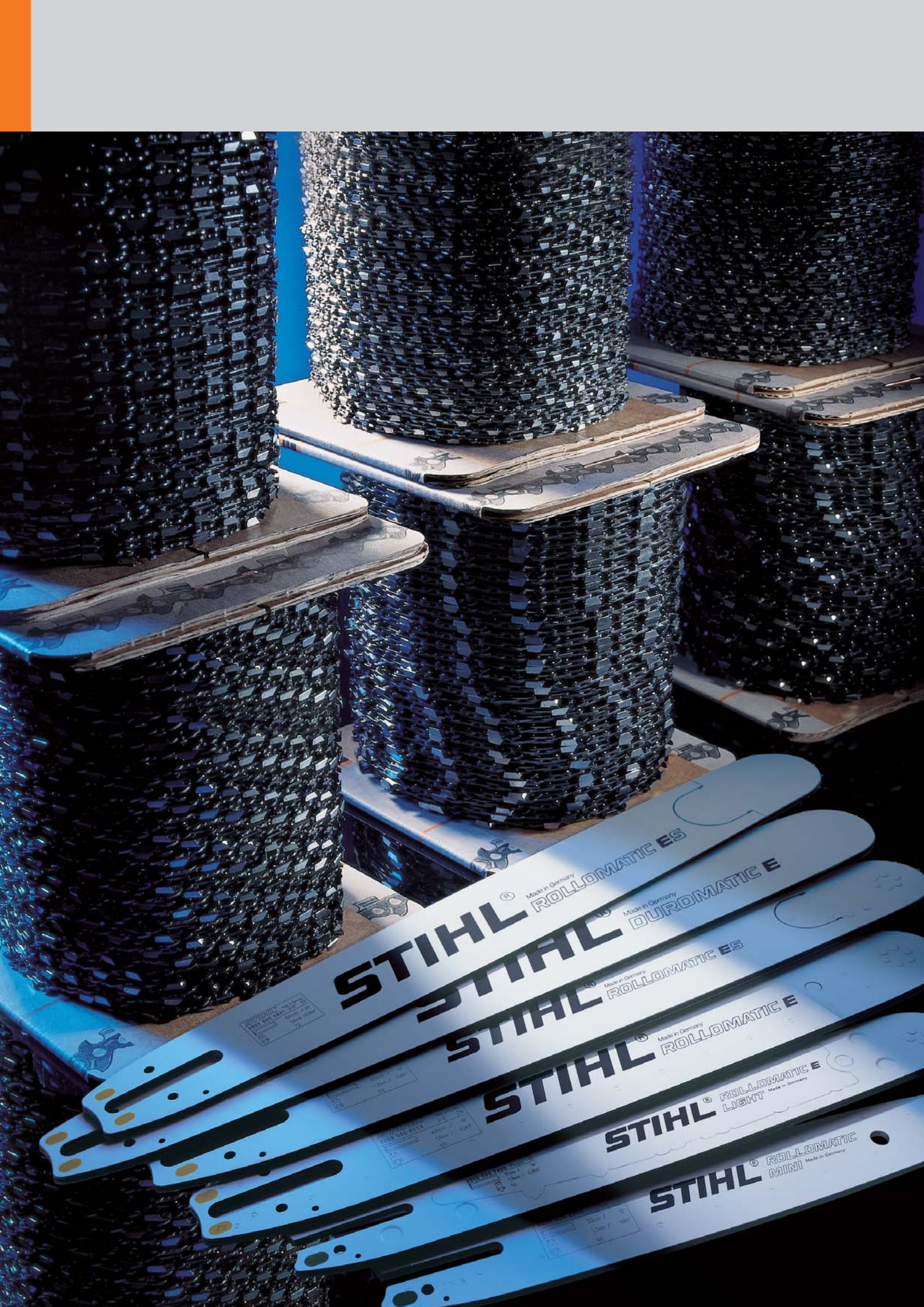

**STIHL** Made in Germany ROLLOMATIC ES

**STIHL** Made in Germany DUROMATIC E

**STIHL** Made in Germany ROLLOMATIC ES

**STIHL** Made in Germany ROLLOMATIC E

**STIHL** Made in Germany ROLLOMATIC E LIGHT

**STIHL** Made in Germany ROLLOMATIC MINI

Важной составляющей любой бензо и электропилы является ее режущая гарнитура. Несмотря на технические характеристики двигателя и на оснащенность самой пилы, результат напрямую зависит от качества и степени износа пильной цепи, направляющей шины и цепной звездочки. STIHL – единственный производитель мотопил в мире, который самостоятельно разрабатывает и производит режущую гарнитуру. Цепи и шины STIHL отличаются своим высоким качеством, надежностью и производительностью.

В этом каталоге вы найдете актуальный ассортимент цепей STIHL, а также удобный путеводитель по применению их на пилах STIHL, а также других производителей, встречающихся на российском рынке. В качестве дополнительной информации в каталоге мы предлагаем путеводитель по шинам для мотопил STIHL и информацию о комплектующих к пильным цепям и направляющим шинам STIHL

## Оглавление

<b>Ассортимент цепей STIHL 2011</b>	4	OLEO-MAC	24
<b>Пильные цепи для моторных пил STIHL</b>	6	PARTNER	26
<b>Пильные цепи для моторных пил других марок</b>	13	POULAN	27
AL-KO	13	RYOBI	27
ALPINA	13	SHINDAIWA	27
BLACK&DECKER	14	SOLO	28
BOSCH	14	STIGA	29
CHAMPION	14	STURM	30
DOLMAR	15	SUNGARDEN	30
ECHO	16	ZENOAH KOMATSU	30
EFCO	17	ИНТЕРСКОЛ	31
EINHELL	18	КАЛИБР	31
HITACHI	18	Зид	31
HOMELITE	18	ЭНЕРГОМАШ	32
HUSQVARNA	19	<b>Направляющие шины для моторных пил STIHL</b>	33
JONSERED	21	<b>Комплектующие к пильным цепям STIHL</b>	44
MAKITA	22	<b>Комплектующие к направляющим шинам STIHL</b>	48
MCCULLOCH	23		

# Ассортимент цепей STIHL 2011

		Дюймы	1/4"	3/8" PICCO		.325"		3/8"			.404"					
		мм	1,3	1,1	1,3	1,3	1,5	1,6	1,3	1,5	1,6	1,5	1,6	2,0		
		дюймы	.050	.043	.050	.050	.058	.063	.050	.058	.063	.058	.063	.078		
Rapid	Standard	RCK												3812		
		RCX												3958		
		RCXK												3895		
	Micro	RM													3668	
		RMC	3660				3627	3628	3629	3650	3651	3652				
		RMS	3661													
		RMC3					3632	3633	3634	3662		3664				
		RMK													3860	
		RMF								3654					3671	
		RMX										3653			3638	
		RMH													3995	3996
		RMHS														3620
		RMU										3655				
	Super	RS													3946	
		RSC					3637	3638	3639	3623	3622	3621				
		RSC3								3624		3626				
		RSK								3874		3898			3846	
		RSF								3953	3913	3979	3924	3911		
		RSLK								3640		3641				
		RSLF													3851	
RSLFK											3643					
Duro	RD								3948		3943					
	RD3					3665	3666	3667								
	RDR										3944					
Picco	Micro	PMC				3613										
		PMC3				3636										
		PMX				3614										
		PMY				3615										
	Super	PS3				3616										
	Mini	PMMC3			3610											
	Duro	PD3				3612										

мм	дюймы	мм	мм
6,35	1/4	0,65	4
8,25	.325	0,65	4,8
9,32	3/8 P	0,65	4
9,32	3/8	0,65	5,2
RD, RDR		0,65	-
10,26	.404	0,8	5,5

## Последующие буквы и цифры

- Z** Бугорчатое соединительное звено для снижения отдачи.
- C** Comfort. Приподнимаемая задняя часть режущего зуба для гашения вибрации.
- D** Duro. Режущие зубья из твердого сплава.
- F** Full-Skip
- H** Harvester или в варианте RSLHK - Semi-Skip.
- K** Klassik
- L** Шлифованные кромки
- M** Mini
- U** Unverchromt. Без хромового покрытия.
- X** Продольная распиловка, угол заточки 10°.
- Y** Двойной зуб

## Первая буква

**R** Rapid

**P** Picco

## Вторая буква

**C** Standard

**M** Micro

**S** Super

**D** Duro

### Rapid Standard



Цепь с закругленными зубьями и закругленной лопаткой отлично подходит для валки леса, раскряжевки и обрезки сучьев

### Rapid Micro



Универсальная цепь с полудолотообразными зубьями и притупленной по бокам лопаткой – для высоких требований профессионалов и полупрофессионалов в сельской, строительной и лесной промышленности

### Rapid Super



Высокопроизводительная цепь с долотообразными зубьями и лопаткой прямоугольной формы с острой кромкой. Идеальна для валки леса, раскряжевки и обрезки сучьев на пилах средней и высокой мощности

### Rapid Duro 3/8"



Цепь с твердосплавными вставками на зубьях для специального использования. Отлично подходит для твердой, загрязненной древесины а также для аварийно-спасательных работ

### Rapid Micro Spezial



Специальная цепь для высокоточной резки, применяется при уходе за деревьями и фигурной резке по дереву

### Rapid Duro .325"



Профессиональная цепь с режущими зубьями из твердого сплава. Сделана по той же эксклюзивной технологии, что и Picco Duro. В 4 раза дольше острая. Отлично подходит для грязной древесины и более устойчива к короткому контакту с землей

### Picco Micro



Низкопрофильная цепь с полудолотообразными зубьями с пониженной отдачей. Применяется в сельскохозяйственной и строительной отраслях, а также идеально подходит для любителей и случайных пользователей

### Picco Super



Первая в мире низкопрофильная цепь с полностью долотообразными зубьями. Целевая аудитория – профессионалы лесной отрасли и ухода за деревьями. Беспрецедентная производительность пиления. Очень чистый рез, низкая вибрация, отличная врезаемость

### Picco Duro



Первая в мире низкопрофильная цепь с режущими зубьями из твердого сплава. Остается острой в 4 раза дольше, чем стандартные цепи. Отлично подходит для загрязненной древесины, более устойчива к короткому контакту с землей

### Picco Micro Mini



Низкопрофильная цепь высокой точности с полудолотообразными зубьями с уменьшенной шириной пропила. Специально для малогабаритных пил малой мощности

# Пильные цепи для моторных пил STIHL

Модель	Длина	Шаг	Паз	Кол-во звеньев	Цепь	Полное название	Артикул
017, 018, MS 170, MS 180, MS 181, MS 192, MS 190 T, MS 192 T, E 14, E 140, MSE 140, HTE 60, HT 75, HT 101, HT 131, HT-KM	30/12	3/8"	1,1	44	61PMMC3	Picco Micro Mini C3	3610 000 0044
017, 018, MS 170, MS 180, MS 181, MS 192, MS 190 T, MS 192 T, E 14, E 140, MSE 140	35/14	3/8"	1,1	50	61PMMC3	Picco Micro Mini C3	3610 000 0050
017, 018, MS 170, MS 180, MS 181, MS 192, MS 190 T, MS 192 T, E 14, E 140, MSE 140	40/16	3/8"	1,1	55	61PMMC3	Picco Micro Mini C3	3610 000 0055
017, 018, MS 170, MS 180, MS 181, MS 192, MS 190 T, MS 192 T, MS 200, 020 T, MS 200 T, 021, 023, 025, MS 210, MS 211, MS 230, MS 250, E 140, MSE 140, E 160, MSE 160, E 180, MSE 180	25/10	1/4"	1,3	56	13RMC	Rapid Micro C	3660 000 0056
					13RMS	Rapid Micro Spezial	3661 000 0056
017, 018, MS 170, MS 180, MS 181, MS 192, MS 190 T, MS 192 T, MS 200, 020 T, MS 200 T, 021, 023, 025, MS 210, MS 211, MS 230, MS 250, E 140, MSE 140, E 160, MSE 160, E 180, MSE 180	30/12	1/4"	1,3	64	13RMC	Rapid Micro C	3660 000 0064
					13RMS	Rapid Micro Spezial	3661 000 0064
017, 018, MS 170, MS 180, MS 181, MS 192, MS 190 T, MS 192 T, MS 200, 020 T, MS 200 T, 021, 023, 025, MS 210, MS 211, MS 230, MS 241, MS 250, E 14, E 140, MSE 140, E 160, MSE 160, E 180, MSE 180	30/12	3/8"	1,3	44	63PMC3	Picco Micro C3	3636 000 0044
					63PMC	Picco Micro C	3613 000 0044
					63PD3	Picco Duro	3612 000 0044
					63PS3	Picco Super	3616 000 0044
MS 240, 026, MS 260, MS 261	32/13	3/8"	1,3	50	63PMC3	Picco Micro C3	3636 000 0050
					63PMC	Picco Micro C	3613 000 0050
					63PD3	Picco Duro	3612 000 0050
					63PS3	Picco Super	3616 000 0050
MS 200, 021, 023, 025, MS 210, MS 211, MS 230, MS 250	35/14	1/4"	1,3	72	13RMC	Rapid Micro C	3660 000 0072
					13RMS	Rapid Micro Spezial	3661 000 0072
017, 018, MS 170, MS 180, MS 181, MS 192, MS 190 T, MS 192 T, MS 200, 020 T, MS 200 T, 021, 023, 025, MS 210, MS 211, MS 230, MS 241, MS 250, E 14, E 140, MSE 140, E 160, MSE 160, E 180, MSE 180	35/14	3/8"	1,3	50	63PMC3	Picco Micro C3	3636 000 0050
					63PMC	Picco Micro C	3613 000 0050
					63PD3	Picco Duro	3612 000 0050
					63PS3	Picco Super	3616 000 0050
MS 200, 021, 023, 025, MS 210, MS 211, MS 230, MS 241, MS 250	40/16	1/4"	1,3	80	13RMC	Rapid Micro C	3660 000 0080
					13RMS	Rapid Micro Spezial	3661 000 0080
017, 018, MS 170, MS 180, MS 181, MS 192, MS 190 T, MS 192 T, MS 200, 020 T, MS 200 T, 021, 023, 025, MS 210, MS 211, MS 230, MS 241, MS 250, E 14, E 140, MSE 140, E 160, MSE 160, E 180, MSE 180	40/16	3/8"	1,3	55	63PMC3	Picco Micro C3	3636 000 0055
					63PMC	Picco Micro C	3613 000 0055
					63PD3	Picco Duro	3612 000 0055
					63PS3	Picco Super	3616 000 0055
021, 023, 025, MS 210, MS 211, MS 230, MS 241, MS 250, E 140, MSE 140, E 160, MSE 160, E 180, MSE 180	40/16	3/8"	1,3	56	63PMC3	Picco Micro C3	3636 000 0056
					63PMC	Picco Micro C	3613 000 0056
					63PD3	Picco Duro	3612 000 0056
					63PS3	Picco Super	3616 000 0056
MS 240, 026, MS 260, MS 261	40/16	3/8"	1,3	60	63PMC3	Picco Micro C3	3636 000 0060
					63PMC	Picco Micro C	3613 000 0060
					63PD3	Picco Duro	3612 000 0060
					63PS3	Picco Super	3616 000 0060
MS 200, 020 T, MS 200 T, 025, MS 250, E 140, MSE 140, E 160, MSE 160, E 180, MSE 180	45/18	3/8"	1,3	61	63PMC3	Picco Micro C3	3636 000 0061
					63PMC	Picco Micro C	3613 000 0061
					63PD3	Picco Duro	3612 000 0061
					63PS3	Picco Super	3616 000 0061
021, 023, 025, MS 210, MS 211, MS 230, MS 241, MS	45/18	3/8"	1,3	62	63PMC3	Picco Micro C3	3636 000 0062

Модель	Длина	Шаг	Паз	Кол-во звеньев	Цепь	Полное название	Артикул
250, E 140, MSE 140, E 160, MSE 160, E 180, MSE 180					63PMC	Picco Micro C	3613 000 0062
					63PD3	Picco Duro	3612 000 0062
					63PS3	Picco Super	3616 000 0062
MS 240, 026, MS 260, MS 261	45/18	3/8"	1,3	66	63PMC3	Picco Micro C3	3636 000 0066
					63PMC	Picco Micro C	3613 000 0066
					63PD3	Picco Duro	3612 000 0066
					63PS3	Picco Super	3616 000 0066
064, MS 640, 066, MS 660 (LOGOSOL)	45/18	3/8"	1,3	66	63PMX	Picco Micro X	3614 000 0066
064, MS 640, 066, MS 660 (LOGOSOL)	50/20	3/8"	1,3	72	63PMX	Picco Micro X	3614 000 0072
064, MS 640, 066, MS 660 (LOGOSOL)	63/25	3/8"	1,3	84	63PMX	Picco Micro X	3614 000 0084
MS 240, 026, MS 260, MS 261, MS 270, MS 280, 029, MS 290, MS 310, 039, MS 390	32/13	.325"	1,5	56	25RMC	Rapid Micro C	3628 000 0056
					25RMC3	Rapid Micro C3	3633 000 0056
					25RSC	Rapid Super C	3638 000 0056
					25RD3	Rapid Duro	3666 000 0056
034, MS 340, MS 341, 036, MS 360, MS 361, MS 362	32/13	.325"	1,5	57	25RMC	Rapid Micro C	3628 000 0057
					25RMC3	Rapid Micro C3	3633 000 0057
					25RSC	Rapid Super C	3638 000 0057
					25RD3	Rapid Duro	3666 000 0057
021, 023, 025, MS 210, MS 211, MS 230, MS 241, MS 250	35/14	.325"	1,5	56	25RMC	Rapid Micro C	3628 000 0056
					25RMC3	Rapid Micro C3	3633 000 0056
					25RSC	Rapid Super C	3638 000 0056
					25RD3	Rapid Duro	3666 000 0056
MS 240, 026, MS 260, MS 261, MS 270, MS 280, 029, MS 290, MS 310, 039, MS 390, 034, MS 340, MS 341, 036, MS 360, MS 361, MS 362	37/15	.325"	1,5	62	25RMC	Rapid Micro C	3628 000 0062
					25RMC3	Rapid Micro C3	3633 000 0062
					25RSC	Rapid Super C	3638 000 0062
					25RD3	Rapid Duro	3666 000 0062
034, MS 340, MS 341, 036, MS 360, MS 361, MS 362	37/15	.325"	1,5	64	25RMC	Rapid Micro C	3628 000 0064
					25RMC3	Rapid Micro C3	3633 000 0064
					25RSC	Rapid Super C	3638 000 0064
					25RD3	Rapid Duro	3666 000 0064
MS 240, 026, MS 260, MS 261, MS 270, MS 280, 029, MS 290, MS 310, 039, MS 390	32/13	.325"	1,6	56	26RMC	Rapid Micro C	3629 000 0056
					26RMC3	Rapid Micro C3	3634 000 0056
					26RSC	Rapid Super C	3639 000 0056
					26RD3	Rapid Duro	3667 000 0056
034, MS 340, MS 341, 036, MS 360, MS 361, MS 362	32/13	.325"	1,6	57	26RMC	Rapid Micro C	3629 000 0057
					26RMC3	Rapid Micro C3	3634 000 0057
					26RSC	Rapid Super C	3639 000 0057
					26RD3	Rapid Duro	3667 000 0057
MS 240, 026, MS 260, MS 261, MS 270, MS 280, 029, MS 290, MS 310, 039, MS 390, 034, MS 340, MS 341, 036, MS 360, MS 361, MS 362	32/13	3/8"	1,6	50	36RMC	Rapid Micro C	3652 000 0050
					36RSC	Rapid Super C	3621 000 0050
					36RMC3	Rapid Micro C3	3664 000 0050
					36RSC3	Rapid Super C3	3626 000 0050
					36RD	Rapid Duro	3943 000 0050
					36RSK	Rapid Super Klassik	3898 000 0050
021, 023, 025, MS 210, MS 211, MS 230, MS 241, MS 250, E 14	35/14	.325"	1,6	56	26RMC	Rapid Micro C	3629 000 0056
					26RMC3	Rapid Micro C3	3634 000 0056
					26RSC	Rapid Super C	3639 000 0056
					26RD3	Rapid Duro	3667 000 0056

# Пильные цепи для моторных пил STIHL

Модель	Длина	Шаг	Паз	Кол-во звеньев	Цепь	Полное название	Артикул
E 20, E 220, MSE 220	37/15	.325"	1,6	63	26RMC	Rapid Micro C	3629 000 0063
					26RMC3	Rapid Micro C3	3634 000 0063
					26RSC	Rapid Super C	3639 000 0063
					26RD3	Rapid Duro	3667 000 0063
MS 240, 026, MS 260, MS 261, MS 270, MS 280, 029, MS 290, MS 310, 039, MS 390, 034, MS 340, MS 341, 036, MS 360, MS 361, MS 362	37/15	.325"	1,6	62	26RMC	Rapid Micro C	3629 000 0062
					26RMC3	Rapid Micro C3	3634 000 0062
					26RSC	Rapid Super C	3639 000 0062
					26RD3	Rapid Duro	3667 000 0062
034, MS 340, MS 341, 036, MS 360, MS 361, MS 362, 044, MS 440, MS 441, 046, MS 460	37/15	.325"	1,6	64	26RMC	Rapid Micro C	3629 000 0064
					26RMC3	Rapid Micro C3	3634 000 0064
					26RSC	Rapid Super C	3639 000 0064
					26RD3	Rapid Duro	3667 000 0064
MS 240, 026, MS 260, MS 261, MS 270, MS 280, 029, MS 290, MS 310, 039, MS 390, 034, MS 340, MS 341, 036, MS 360, MS 361, MS 362, 044, MS 440, MS 441, 046, MS 460	37/15	3/8"	1,6	56	36RMC	Rapid Micro C	3652 000 0056
					36RSC	Rapid Super C	3621 000 0056
					36RMC3	Rapid Micro C3	3664 000 0056
					36RSC3	Rapid Super C3	3626 000 0056
					36RD	Rapid Duro	3943 000 0056
					36RSK	Rapid Super Klassik	3898 000 0056
E 20, E 220, MSE 220	37/15	3/8"	1,6	57	36RMC	Rapid Micro C	3652 000 0057
					36RSC	Rapid Super C	3621 000 0057
					36RMC3	Rapid Micro C3	3664 000 0057
					36RSC3	Rapid Super C3	3626 000 0057
					36RD	Rapid Duro	3943 000 0057
					36RSK	Rapid Super Klassik	3898 000 0057
021, 023, 025, MS 210, MS 211, MS 230, MS 241, MS 250, E 14	40/16	.325"	1,6	62	26RMC	Rapid Micro C	3629 000 0062
					26RMC3	Rapid Micro C3	3634 000 0062
					26RSC	Rapid Super C	3639 000 0062
					26RD3	Rapid Duro	3667 000 0062
MS 240, 026, MS 260, MS 261, MS 270, MS 280, 029, MS 290, MS 310, 039, MS 390, E 20, E 220, MSE 220	40/16	.325"	1,6	67	26RMC	Rapid Micro C	3629 000 0067
					26RMC3	Rapid Micro C3	3634 000 0067
					26RSC	Rapid Super C	3639 000 0067
					26RD3	Rapid Duro	3667 000 0067
034, MS 340, MS 341, 036, MS 360, MS 361, MS 362, 044, MS 440, MS 441, 046, MS 460	40/16	.325"	1,6	68	26RMC	Rapid Micro C	3629 000 0068
					26RMC3	Rapid Micro C3	3634 000 0068
					26RSC	Rapid Super C	3639 000 0068
					26RD3	Rapid Duro	3667 000 0068
MS 240, 026, MS 260, MS 261, MS 270, MS 280, 029, MS 290, MS 310, 039, MS 390, 034, MS 340, MS 341, 036, MS 360, MS 361, MS 362, 044, MS 440, MS 441, 046, MS 460, 064, MS 640, MS 650, 066, MS 660, E 20, E 220, MSE 220	40/16	3/8"	1,6	60	36RMC	Rapid Micro C	3652 000 0056
					36RSC	Rapid Super C	3621 000 0056
					36RMC3	Rapid Micro C3	3664 000 0056
					36RSC3	Rapid Super C3	3626 000 0056
					36RD	Rapid Duro	3943 000 0056
					36RSK	Rapid Super Klassik	3898 000 0056
064, MS 640, MS 650, 066, MS 660	40/16	.404"	1,6	55	46RM	Rapid Micro	3668 000 0055
					46RS	Rapid Super	3946 000 0055
					46RSK	Rapid Super K	3846 000 0055
					46RCK	Rapid Standard K	3812 000 0055
					46RMF	Rapid Micro Fullskip	3671 000 0055
					46RMK	Rapid Micro Klassik	3860 000 0055



Модель	Длина	Шаг	Паз	Кол-во звеньев	Цепь	Полное название	Артикул					
025, MS 250	45/18	.325"	1,6	68	46RSF	Rapid Super Fullskip	3911 000 0055					
					26RMC	Rapid Micro C	3629 000 0068					
					26RMC3	Rapid Micro C3	3634 000 0068					
					26RSC	Rapid Super C	3639 000 0068					
					26RD3	Rapid Duro	3667 000 0068					
MS 240, 026, MS 260, MS 261, MS 270, MS 280, 029, MS 290, MS 310, 039, MS 390, E 20, E 220, MSE 220	45/18	.325"	1,6	74	26RMC	Rapid Micro C	3629 000 0074					
					26RMC3	Rapid Micro C3	3634 000 0074					
					26RSC	Rapid Super C	3639 000 0074					
					26RD3	Rapid Duro	3667 000 0074					
034, MS 340, MS 341, 036, MS 360, MS 361, MS 362, 044, MS 440, MS 441, 046, MS 460	45/18	.325"	1,6	75	26RMC	Rapid Micro C	3629 000 0075					
					26RMC3	Rapid Micro C3	3634 000 0075					
					26RSC	Rapid Super C	3639 000 0075					
					26RD3	Rapid Duro	3667 000 0075					
MS 240, 026, MS 260, MS 261, MS 270, MS 280, 029, MS 290, MS 310, 039, MS 390, 034, MS 340, MS 341, 036, MS 360, MS 361, MS 362, 044, MS 440, MS 441, 046, MS 460, 064, MS 640, MS 650, 066, MS 660, E 20, E 220, MSE 220	45/18	3/8"	1,6	66	36RMC	Rapid Micro C	3652 000 0066					
					36RSC	Rapid Super C	3621 000 0066					
					36RMC3	Rapid Micro C3	3664 000 0066					
					36RSC3	Rapid Super C3	3626 000 0066					
					36RD	Rapid Duro	3943 000 0066					
					36RSK	Rapid Super Klassik	3898 000 0066					
064, MS 640, 066, MS 660 (LOGOSOL)	45/18	3/8"	1,6	66	36RMX	Rapid Micro X	3653 000 0066					
064, MS 640, MS 650, 066, MS 660	45/18	.404"	1,6	60	46RM	Rapid Micro	3668 000 0060					
					46RS	Rapid Super	3946 000 0060					
					46RSK	Rapid Super K	3846 000 0060					
					46RCK	Rapid Standard K	3812 000 0060					
					46RMF	Rapid Micro Fullskip	3671 000 0060					
					46RMK	Rapid Micro Klassik	3860 000 0060					
					46RSF	Rapid Super Fullskip	3911 000 0060					
					029, MS 290, MS 310, 039, MS 390, E 20, E 220, MSE 220	50/20	.325"	1,6	81	26RMC	Rapid Micro C	3629 000 0081
										26RMC3	Rapid Micro C3	3634 000 0081
										26RSC	Rapid Super C	3639 000 0081
26RD3	Rapid Duro	3667 000 0081										
034, MS 340, MS 341, 036, MS 360, MS 361, MS 362, 044, MS 440, MS 441, 046, MS 460	50/20	.325"	1,6	82	26RMC	Rapid Micro C	3629 000 0082					
					26RMC3	Rapid Micro C3	3634 000 0082					
					26RSC	Rapid Super C	3639 000 0082					
					26RD3	Rapid Duro	3667 000 0082					
029, MS 290, MS 310, 039, MS 390, 034, MS 340, MS 341, 036, MS 360, MS 361, MS 362, 044, MS 440, MS 441, 046, MS 460, 064, MS 640, MS 650, 066, MS 660, E 20, E 220, MSE 220	50/20	3/8"	1,6	72	36RMC	Rapid Micro C	3652 000 0072					
					36RSC	Rapid Super C	3621 000 0072					
					36RMC3	Rapid Micro C3	3664 000 0072					
					36RSC3	Rapid Super C3	3626 000 0072					
					36RD	Rapid Duro	3943 000 0072					
					36RSK	Rapid Super Klassik	3898 000 0072					
MS 460 R	50/20	3/8"	1,6	72	36RDR	Rapid Duro Rescue	3944 000 0072					
064, MS 640, 066, MS 660 (LOGOSOL)	50/20	3/8"	1,6	72	36RMX	Rapid Micro X	3653 000 0072					
064, MS 640, MS 650, 066, MS 660	50/20	.404"	1,6	66	46RM	Rapid Micro	3668 000 0066					
					46RS	Rapid Super	3946 000 0066					
					46RSK	Rapid Super K	3846 000 0066					
					46RCK	Rapid Standard K	3812 000 0066					
					46RMF	Rapid Micro Fullskip	3671 000 0066					

# Пильные цепи для моторных пил STIHL

Модель	Длина	Шаг	Паз	Кол-во звеньев	Цепь	Полное название	Артикул					
064, MS 640, 066, MS 660 (LOGOSOL)	50/20	.404"	1,6	66	46RMK	Rapid Micro Klassik	3860 000 0066					
					46RSF	Rapid Super Fullskip	3911 000 0066					
088, MS 880	53/21	3/8"	1,6	75	46RMX	Rapid Micro X	3838 000 0066					
					36RMC	Rapid Micro C	3652 000 0075					
					36RSC	Rapid Super C	3621 000 0075					
					36RMC3	Rapid Micro C3	3664 000 0075					
					36RSC3	Rapid Super C3	3626 000 0075					
					36RD	Rapid Duro	3943 000 0075					
					36RSK	Rapid Super Klassik	3898 000 0075					
					46RM	Rapid Micro	3668 000 0068					
088, MS 880	53/21	.404"	1,6	68	46RS	Rapid Super	3946 000 0068					
					46RSK	Rapid Super K	3846 000 0068					
					46RCK	Rapid Standard K	3812 000 0068					
					46RMF	Rapid Micro Fullskip	3671 000 0068					
					46RMK	Rapid Micro Klassik	3860 000 0068					
					46RSF	Rapid Super Fullskip	3911 000 0068					
					36RMC	Rapid Micro C	3652 000 0076					
					36RSC	Rapid Super C	3621 000 0076					
					36RMC3	Rapid Micro C3	3664 000 0076					
					36RSC3	Rapid Super C3	3626 000 0076					
029, MS 290, MS 310, 039, MS 390, 044, MS 440, MS 441, 046, MS 460, 064, MS 640, MS 650, 066, MS 660	55/22	3/8"	1,6	76	36RD	Rapid Duro	3943 000 0076					
					36RSK	Rapid Super Klassik	3898 000 0076					
					36RMC	Rapid Micro C	3652 000 0084					
					36RSC	Rapid Super C	3621 000 0084					
					36RMC3	Rapid Micro C3	3664 000 0084					
					36RSC3	Rapid Super C3	3626 000 0084					
					36RD	Rapid Duro	3943 000 0084					
					36RSK	Rapid Super Klassik	3898 000 0084					
					36RMC	Rapid Micro C	3652 000 0084					
					36RSC	Rapid Super C	3621 000 0084					
029, MS 290, MS 310, 039, MS 390, 044, MS 440, MS 441, 046, MS 460, 064, MS 640, MS 650, 066, MS 660, 088, MS 880	63/25	3/8"	1,6	84	36RMC3	Rapid Micro C3	3664 000 0084					
					36RSC3	Rapid Super C3	3626 000 0084					
					36RD	Rapid Duro	3943 000 0084					
					36RSK	Rapid Super Klassik	3898 000 0084					
					36RMC	Rapid Micro C	3652 000 0084					
					36RSC	Rapid Super C	3621 000 0084					
					36RMC3	Rapid Micro C3	3664 000 0084					
					36RSC3	Rapid Super C3	3626 000 0084					
					36RD	Rapid Duro	3943 000 0084					
					36RSK	Rapid Super Klassik	3898 000 0084					
064, MS 640, 066, MS 660 (LOGOSOL)	63/25	3/8"	1,6	84	36RMX	Rapid Micro X	3653 000 0084					
					46RM	Rapid Micro	3668 000 0077					
064, MS 640, MS 650, 066, MS 660	63/25	.404"	1,6	77	46RS	Rapid Super	3946 000 0077					
					46RSK	Rapid Super K	3846 000 0077					
					46RCK	Rapid Standard K	3812 000 0077					
					46RMF	Rapid Micro Fullskip	3671 000 0077					
					46RMK	Rapid Micro Klassik	3860 000 0077					
					46RSF	Rapid Super Fullskip	3911 000 0077					
					46RMX	Rapid Micro X	3838 000 0077					
					46RM	Rapid Micro	3668 000 0080					
					46RS	Rapid Super	3946 000 0080					
					46RSK	Rapid Super K	3846 000 0080					
064, MS 640, 066, MS 660 (LOGOSOL)	63/25	.404"	1,6	77	46RCK	Rapid Standard K	3812 000 0080					
					46RMF	Rapid Micro Fullskip	3671 000 0080					
					46RMK	Rapid Micro Klassik	3860 000 0080					
					46RSF	Rapid Super Fullskip	3911 000 0080					
					36RMC	Rapid Micro C	3652 000 0098					
					36RSC	Rapid Super C	3621 000 0098					
					36RMC3	Rapid Micro C3	3664 000 0098					
					36RSC3	Rapid Super C3	3626 000 0098					
					088, MS 880	63/25	.404"	1,6	80	46RMX	Rapid Micro X	3838 000 0077
										46RM	Rapid Micro	3668 000 0080
044, MS 440, MS 441, 046, MS 460, 064, MS 640, MS 650, 066, MS 660	75/30	3/8"	1,6	98	46RS	Rapid Super	3946 000 0080					
					46RSK	Rapid Super K	3846 000 0080					
					46RCK	Rapid Standard K	3812 000 0080					
					46RMF	Rapid Micro Fullskip	3671 000 0080					
					46RMK	Rapid Micro Klassik	3860 000 0080					
					46RSF	Rapid Super Fullskip	3911 000 0080					
					36RMC	Rapid Micro C	3652 000 0098					
					36RSC	Rapid Super C	3621 000 0098					
					36RMC3	Rapid Micro C3	3664 000 0098					
					36RSC3	Rapid Super C3	3626 000 0098					

Модель	Длина	Шаг	Паз	Кол-во звеньев	Цепь	Полное название	Артикул
088, MS 880	75/30	3/8"	1,6	100	36RD	Rapid Duro	3943 000 0098
					36RSK	Rapid Super Klassik	3898 000 0098
					36RMC	Rapid Micro C	3652 000 0100
					36RSC	Rapid Super C	3621 000 0100
					36RMC3	Rapid Micro C3	3664 000 0100
					36RSC3	Rapid Super C3	3626 000 0100
					36RD	Rapid Duro	3943 000 0100
064, MS 640, MS 650, 066, MS 660	75/30	.404"	1,6	88	36RSK	Rapid Super Klassik	3898 000 0100
					46RM	Rapid Micro	3668 000 0088
					46RS	Rapid Super	3946 000 0088
					46RSK	Rapid Super K	3846 000 0088
					46RCK	Rapid Standard K	3812 000 0088
					46RMF	Rapid Micro Fullskip	3671 000 0088
					46RMK	Rapid Micro Klassik	3860 000 0088
088, MS 880	75/30	.404"	1,6	91	46RSF	Rapid Super Fullskip	3911 000 0088
					46RM	Rapid Micro	3668 000 0091
					46RS	Rapid Super	3946 000 0091
					46RSK	Rapid Super K	3846 000 0091
					46RCK	Rapid Standard K	3812 000 0091
					46RMF	Rapid Micro Fullskip	3671 000 0091
					46RMK	Rapid Micro Klassik	3860 000 0091
044, MS 440, MS 441, 046, MS 460, 064, MS 640, MS 650, 066, MS 660	80/32	3/8"	1,6	105	46RSF	Rapid Super Fullskip	3911 000 0091
					36RMC	Rapid Micro C	3652 000 0105
					36RSC	Rapid Super C	3621 000 0105
					36RMC3	Rapid Micro C3	3664 000 0105
					36RSC3	Rapid Super C3	3626 000 0105
					36RD	Rapid Duro	3943 000 0105
					36RSK	Rapid Super Klassik	3898 000 0105
064, MS 640, MS 650, 066, MS 660	80/32	.404"	1,6	95	46RM	Rapid Micro	3668 000 0095
					46RS	Rapid Super	3946 000 0095
					46RSK	Rapid Super K	3846 000 0095
					46RCK	Rapid Standard K	3812 000 0095
					46RMF	Rapid Micro Fullskip	3671 000 0095
					46RMK	Rapid Micro Klassik	3860 000 0095
					46RSF	Rapid Super Fullskip	3911 000 0095
044, MS 440, MS 441, 046, MS 460, 064, MS 640, MS 650, 066, MS 660, 088, MS 880	90/36	3/8"	1,6	114	36RMC	Rapid Micro C	36520000114
					36RSC	Rapid Super C	36210000114
					36RMC3	Rapid Micro C3	36640000114
					36RSC3	Rapid Super C3	36260000114
					36RD	Rapid Duro	39430000114
					36RSK	Rapid Super Klassik	38980000114
					46RM	Rapid Micro	36680000104
064, MS 640, MS 650, 066, MS 660, 088, MS 880	90/36	.404"	1,6	104	46RS	Rapid Super	39460000104
					46RSK	Rapid Super K	38460000104
					46RCK	Rapid Standard K	38120000104
					46RMF	Rapid Micro Fullskip	36710000104
					46RMK	Rapid Micro Klassik	38600000104
					46RSF	Rapid Super Fullskip	39110000104

# Пильные цепи для моторных пил STIHL

Модель	Длина	Шаг	Паз	Кол-во звеньев	Цепь	Полное название	Артикул
088, MS 880	90/36	.404"	1,6	108	46RM	Rapid Micro	3668 000 0108
					46RS	Rapid Super	3946 000 0108
					46RSK	Rapid Super K	3846 000 0108
					46RCK	Rapid Standard K	3812 000 0108
					46RMF	Rapid Micro Fullskip	3671 000 0108
					46RMK	Rapid Micro Klassik	3860 000 0108
					46RSF	Rapid Super Fullskip	3911 000 0108
088, MS 880	105/42	3/8"	1,6	135	36RMC	Rapid Micro C	3652 000 0135
					36RSC	Rapid Super C	3621 000 0135
					36RMC3	Rapid Micro C3	3664 000 0135
					36RSC3	Rapid Super C3	3626 000 0135
					36RD	Rapid Duro	3943 000 0135
					36RSK	Rapid Super Klassik	3898 000 0135
					46RM	Rapid Micro	3668 000 0123
088, MS 880	105/42	.404"	1,6	123	46RS	Rapid Super	3946 000 0123
					46RSK	Rapid Super K	3846 000 0123
					46RCK	Rapid Standard K	3812 000 0123
					46RMF	Rapid Micro Fullskip	3671 000 0123
					46RMK	Rapid Micro Klassik	3860 000 0123
					46RSF	Rapid Super Fullskip	3911 000 0123
					088, MS 880	120/48	3/8"
36RSC	Rapid Super C	3621 000 0152					
36RMC3	Rapid Micro C3	3664 000 0152					
36RSC3	Rapid Super C3	3626 000 0152					
36RD	Rapid Duro	3943 000 0152					
36RSK	Rapid Super Klassik	3898 000 0152					
46RM	Rapid Micro	3668 000 0138					
088, MS 880	120/48	.404"	1,6	138	46RS	Rapid Super	3946 000 0138
					46RSK	Rapid Super K	3846 000 0138
					46RCK	Rapid Standard K	3812 000 0138
					46RMF	Rapid Micro Fullskip	3671 000 0138
					46RMK	Rapid Micro Klassik	3860 000 0138
					46RSF	Rapid Super Fullskip	3911 000 0138
					088, MS 880	150/60	3/8"
36RSC	Rapid Super C	3621 000 0189					
36RMC3	Rapid Micro C3	3664 000 0189					
36RSC3	Rapid Super C3	3626 000 0189					
36RD	Rapid Duro	3943 000 0189					
36RSK	Rapid Super Klassik	3898 000 0189					
46RM	Rapid Micro	3668 000 0173					
088, MS 880	150/60	.404"	1,6	173	46RS	Rapid Super	3946 000 0173
					46RSK	Rapid Super K	3846 000 0173
					46RCK	Rapid Standard K	3812 000 0173
					46RMF	Rapid Micro Fullskip	3671 000 0173
					46RMK	Rapid Micro Klassik	3860 000 0173
					46RSF	Rapid Super Fullskip	3911 000 0173

# Пильные цепи для моторных пил других марок

Модель	Длина	Шаг	Паз	Кол-во звеньев	Цепь	Полное название	Артикул
<b>AL-KO</b>							
BKS 35/35	35/14	3/8"	1,3	52	63PMC3	Picco Micro C3	3636 000 0052
					63PMC	Picco Micro C	3613 000 0052
					63PD3	Picco Duro	3612 000 0052
KE 1800/35, KE 2000/35	35/14	3/8"	1,3	50	63PMC3	Picco Micro C3	3636 000 0050
					63PMC	Picco Micro C	3613 000 0050
					63PD3	Picco Duro	3612 000 0050
BKS 40/40	40/16	3/8"	1,3	54	63PMC3	Picco Micro C3	3636 000 0054
					63PMC	Picco Micro C	3613 000 0054
					63PD3	Picco Duro	3612 000 0054
KE 1800/40, KE 2200/40	40/16	3/8"	1,3	55	63PMC3	Picco Micro C3	3636 000 0055
					63PMC	Picco Micro C	3613 000 0055
					63PD3	Picco Duro	3612 000 0055
BKS 42/45	45/18	3/8"	1,3	60	63PMC3	Picco Micro C3	3636 000 0060
					63PMC	Picco Micro C	3613 000 0060
					63PD3	Picco Duro	3612 000 0060
<b>ALPINA</b>							
PR270 Carving	25/10	1/4"	1,3	60	13RMC	Rapid Micro C	3660 000 0060
					13RMS	Rapid Micro Spezial	3661 000 0060
PR270	25/10	3/8"	1,3	40	63PMC3	Picco Micro C3	3636 000 0040
					63PMC	Picco Micro C	3613 000 0040
					63PD3	Picco Duro	3612 000 0040
330, 380, 438	30/12	3/8"	1,3	44	63PMC3	Picco Micro C3	3636 000 0044
					63PMC	Picco Micro C	3613 000 0044
					63PD3	Picco Duro	3612 000 0044
P 402 S	33/13	.325"	1,3	56	23RMC	Rapid Micro C	3627 000 0056
					23RMC3	Rapid Micro C3	3632 000 0056
					23RSC	Rapid Super C	3637 000 0056
330, 380, 438, EA 35, ES 155, P 361, P 371, EA 170	35/14	3/8"	1,3	50	63PMC3	Picco Micro C3	3636 000 0050
					63PMC	Picco Micro C	3613 000 0050
					63PD3	Picco Duro	3612 000 0050
P 352	35/14	3/8"	1,3	52	63PMC3	Picco Micro C3	3636 000 0052
					63PMC	Picco Micro C	3613 000 0052
					63PD3	Picco Duro	3612 000 0052
P 411	38/15	.325"	1,3	64	23RMC	Rapid Micro C	3627 000 0064
					23RMC3	Rapid Micro C3	3632 000 0064
					23RSC	Rapid Super C	3637 000 0064
330, 380, 438, EA 45, ES 202Q, P 382 S, P 391	40/16	3/8"	1,3	56	63PMC3	Picco Micro C3	3636 000 0056
					63PMC	Picco Micro C	3613 000 0056
					63PD3	Picco Duro	3612 000 0056
P 420, P 422 S, P 440, P 462 S	40/16	.325"	1,3	66	23RMC	Rapid Micro C	3627 000 0066
					23RMC3	Rapid Micro C3	3632 000 0066
					23RSC	Rapid Super C	3637 000 0066
P 442 S, P 460, P 472 S, P 480, P 482 S	45/18	.325"	1,3	72	23RMC	Rapid Micro C	3627 000 0072
					23RMC3	Rapid Micro C3	3632 000 0072
					23RSC	Rapid Super C	3637 000 0072

# Пильные цепи для моторных пил других марок

Модель	Длина	Шаг	Паз	Кол-во звеньев	Цепь	Полное название	Артикул
540	30/12	.325"	1,5	55	25RMC	Rapid Micro C	3628 000 0055
					25RMC3	Rapid Micro C3	3633 000 0055
					25RSC	Rapid Super C	3638 000 0055
540	35/14	.325"	1,5	61	25RMC	Rapid Micro C	3628 000 0061
					25RMC3	Rapid Micro C3	3633 000 0061
					25RSC	Rapid Super C	3638 000 0061
540	40/16	.325"	1,5	65	25RMC	Rapid Micro C	3628 000 0065
					25RMC3	Rapid Micro C3	3633 000 0065
					25RSC	Rapid Super C	3638 000 0065
540, P 522 S	45/18	.325"	1,5	72	25RMC	Rapid Micro C	3628 000 0072
					25RMC3	Rapid Micro C3	3633 000 0072
					25RSC	Rapid Super C	3638 000 0072
P 680	45/18	3/8"	1,5	66	35RMC	Rapid Micro C	3651 000 0066
					35RSC	Rapid Super C	3622 000 0066
P 510, P 522 S	50/20	.325"	1,5	78	25RMC	Rapid Micro C	3628 000 0078
					25RMC3	Rapid Micro C3	3633 000 0078
					25RSC	Rapid Super C	3638 000 0078
P 680	50/20	3/8"	1,5	72	35RMC	Rapid Micro C	3651 000 0072
					35RSC	Rapid Super C	3622 000 0072

## BLACK&DECKER

CS 30, GK 1430, GK 1630T, GK 1730, GK 1930, GK 1930T	30/12	3/8"	1,3	44	63PMC3	Picco Micro C3	3636 000 0044
					63PMC	Picco Micro C	3613 000 0044
					63PD3	Picco Duro	3612 000 0044
CS 35, GK 1435, GK 1635T, GK 1735, GK 1935, GK 1935T	30/12	3/8"	1,3	49	63PMC3	Picco Micro C3	3636 000 0049
					63PMC	Picco Micro C	3613 000 0049
					63PD3	Picco Duro	3612 000 0049
GK 1440, GK 1640T, GK 1740, GK 1940, GK 1940T, GK 2040T	40/16	3/8"	1,3	56	63PMC3	Picco Micro C3	3636 000 0056
					63PMC	Picco Micro C	3613 000 0056
					63PD3	Picco Duro	3612 000 0056

## BOSCH

AKE 30 S	30/12	3/8"	1,1	45	61PMMC3	Picco Micro Mini C3	3610 000 0045
AKE 35 S	35/14	3/8"	1,1	52	61PMMC3	Picco Micro Mini C3	3610 000 0052
AKE 40 S	40/16	3/8"	1,1	57	61PMMC3	Picco Micro Mini C3	3610 000 0057
GKE 35 BC	35/14	3/8"	1,3	52	63PMC3	Picco Micro C3	3636 000 0052
					63PMC	Picco Micro C	3613 000 0052
					63PD3	Picco Duro	3612 000 0052
AKE 40 Pro, GKE 40 BC	40/16	3/8"	1,3	57	63PMC3	Picco Micro C3	3636 000 0057
					63PMC	Picco Micro C	3613 000 0057
					63PD3	Picco Duro	3612 000 0057

## CHAMPION

116, 138, 216, 220N, 242, 320N, 335, 420	40/16	3/8"	1,3	56	63PMC3	Picco Micro C3	3636 000 0056
					63PMC	Picco Micro C	3613 000 0056
					63PD3	Picco Duro	3612 000 0056
138, 242, 255, 341, 345, 422	45/18	3/8"	1,3	61	63PMC3	Picco Micro C3	3636 000 0061
					63PMC	Picco Micro C	3613 000 0061
					63PD3	Picco Duro	3612 000 0061

Модель	Длина	Шаг	Паз	Кол-во звеньев	Цепь	Полное название	Артикул
<b>DOLMAR</b>							
ES-31 A	30/12	3/8"	1,1	44	61PMMC3	Picco Micro Mini C3	3610 000 0044
ES-36 A	35/14	3/8"	1,1	50	61PMMC3	Picco Micro Mini C3	3610 000 0050
ES-40 A	40/16	3/8"	1,1	55	61PMMC3	Picco Micro Mini C3	3610 000 0055
PS-3400 TH	25/10	3/8"	1,3	41	63PMC3	Picco Micro C3	3636 000 0041
					63PMC	Picco Micro C	3613 000 0041
					63PD3	Picco Duro	3612 000 0041
ES-2030 A, PS-3400, PS-3400 TH	30/12	3/8"	1,3	46	63PMC3	Picco Micro C3	3636 000 0046
					63PMC	Picco Micro C	3613 000 0046
					63PD3	Picco Duro	3612 000 0046
PS-410, PS-411	33/13	.325"	1,3	56	23RMC	Rapid Micro C	3627 000 0056
					23RMC3	Rapid Micro C3	3632 000 0056
					23RSC	Rapid Super C	3637 000 0056
ES-2035 A, PS-330, PS-34, PS-340, PS-3400, PS-3400 TH, PS-342, PS-344, PS-350, PS-400, PS-401	35/14	3/8"	1,3	52	63PMC3	Picco Micro C3	3636 000 0052
					63PMC	Picco Micro C	3613 000 0052
					63PD3	Picco Duro	3612 000 0052
PS-410, PS-411	38/15	.325"	1,3	64	23RMC	Rapid Micro C	3627 000 0064
					23RMC3	Rapid Micro C3	3632 000 0064
					23RSC	Rapid Super C	3637 000 0064
ES-2040 A, PS-330, PS-34, PS-340, PS-341, PS-342, PS-344, PS-350, PS-400, PS-401	40/16	3/8"	1,3	56	63PMC3	Picco Micro C3	3636 000 0056
					63PMC	Picco Micro C	3613 000 0056
					63PD3	Picco Duro	3612 000 0056
PS-410, PS-411	38/15	.325"	1,3	72	23RMC	Rapid Micro C	3627 000 0072
					23RMC3	Rapid Micro C3	3632 000 0072
					23RSC	Rapid Super C	3637 000 0072
ES-2045 A	45/18	3/8"	1,3	61	63PMC3	Picco Micro C3	3636 000 0061
					63PMC	Picco Micro C	3613 000 0061
					63PD3	Picco Duro	3612 000 0061
109, 109 HS, 110i, 111, 115i	33/13	.325"	1,5	56	25RMC	Rapid Micro C	3628 000 0056
					25RMC3	Rapid Micro C3	3633 000 0056
					25RSC	Rapid Super C	3638 000 0056
109, 109 HS, 110i, 111, 115i	33/13	3/8"	1,5	52	35RMC	Rapid Micro C	3651 000 0052
					35RSC	Rapid Super C	3622 000 0052
109, 109 HS, 110i, 111, 115i	38/15	.325"	1,5	64	25RMC	Rapid Micro C	3628 000 0064
					25RMC3	Rapid Micro C3	3633 000 0064
					25RSC	Rapid Super C	3638 000 0064
109, 109 HS, 110i, 111, 115i	38/15	3/8"	1,5	56	35RMC	Rapid Micro C	3651 000 0056
					35RSC	Rapid Super C	3622 000 0056
109, 109 HS, 110i, 111, 115i	45/18	.325"	1,5	72	25RMC	Rapid Micro C	3628 000 0072
					25RMC3	Rapid Micro C3	3633 000 0072
					25RSC	Rapid Super C	3638 000 0072
109, 109 HS, 110i, 111, 115i, PS-4600, PS-5000, PS-6000i, PS-64000, PS-64000 HS, PS-7300, PS-7300 HS, PS-7900, PS-7900 HS	45/18	3/8"	1,5	64	35RMC	Rapid Micro C	3651 000 0064
					35RSC	Rapid Super C	3622 000 0072
PS-4600, PS-5000, PS-6000i, PS-64000, PS-64000 HS, PS-7300, PS-7300 HS, PS-7900, PS-7900 HS, PS-9010, PS-9010 HS	50/20	3/8"	1,5	72	35RMC	Rapid Micro C	3651 000 0072
					35RSC	Rapid Super C	3622 000 0072

# Пильные цепи для моторных пил других марок

Модель	Длина	Шаг	Паз	Кол-во звеньев	Цепь	Полное название	Артикул
PS-6400, PS-6400 HS, PS-7300, PS-7300 HS, PS-7900, PS-7900 HS, PS-9010, PS-9010 HS	60/24	3/8"	1,5	81	35RMC	Rapid Micro C	3651 000 0081
					35RSC	Rapid Super C	3622 000 0081
PS-7900, PS-7900 HS	70/28	3/8"	1,5	92	35RMC	Rapid Micro C	3651 000 0092
					35RSC	Rapid Super C	3622 000 0092
PS-9010, PS-9010 HS	74/30	3/8"	1,5	96	35RMC	Rapid Micro C	3651 000 0096
					35RSC	Rapid Super C	3622 000 0096
<b>ЕCHO</b>							
CS-310ES	30/12	3/8"	1,1	45	61PMMC3	Picco Micro Mini C3	3610 000 0045
CS-310ES	35/14	3/8"	1,1	52	61PMMC3	Picco Micro Mini C3	3610 000 0052
CS-2600ESC, CS-260TESC	25/10	1/4"	1,3	60	13RMC	Rapid Micro C	3660 000 0060
					13RMS	Rapid Micro Spezial	3661 000 0060
CS-2600(ES), CS-260TES, CS-2700ES, CS-270WES	25/10	3/8"	1,3	40	63PMC3	Picco Micro C3	3636 000 0040
					63PMC	Picco Micro C	3613 000 0040
					63PD3	Picco Duro	3612 000 0040
					63PMC3	Picco Micro C3	3636 000 0047
CS-2600(ES), CS-260TES, CS-2700ES, CS-270WES, CS-3000, CS-3500, CS-310ES, CS-320T(ES), CS-3400, 3500, CS-3501, CS-350T(ES), CS-350WES, CS-351WES	30/12	3/8"	1,3	47	63PMC	Picco Micro C	3613 000 0047
					63PD3	Picco Duro	3612 000 0047
					63PMC3	Picco Micro C3	3636 000 0047
					63PMC	Picco Micro C	3613 000 0047
CS-3000, CS-3050, CS-310ES, CS-320T(ES), CS-3400, CS-3500, CS-3501, CS-350T(ES), CS-350WES, CS-351WES, CS-370ES	35/14	3/8"	1,3	53	63PMC3	Picco Micro C3	3636 000 0053
					63PMC	Picco Micro C	3613 000 0053
					63PD3	Picco Duro	3612 000 0053
CS-3700ES, CS-4200ES	40/16	.325"	1,3	66	23RMC	Rapid Micro C	3627 000 0066
					23RMC3	Rapid Micro C3	3632 000 0066
					23RSC	Rapid Super C	3637 000 0066
					23RMC	Rapid Micro C	3627 000 0068
CS-396(SP)	40/16	.325"	1,3	68	23RMC3	Rapid Micro C3	3632 000 0068
					23RSC	Rapid Super C	3637 000 0068
					23RMC	Rapid Micro C	3627 000 0068
					23RMC3	Rapid Micro C3	3632 000 0068
CS-210, CS-320T(ES), CS-3500, CS-3501, CS-350T(ES), CS-350WES, CS-351WES, CS-370ES	40/16	3/8"	1,3	58	63PMC3	Picco Micro C3	3636 000 0058
					63PMC	Picco Micro C	3613 000 0058
					63PD3	Picco Duro	3612 000 0058
CS-3700ES, CS-370ES, CS-4200ES	33/13	.325"	1,5	56	25RMC	Rapid Micro C	3628 000 0056
					25RMC3	Rapid Micro C3	3633 000 0056
					25RSC	Rapid Super C	3638 000 0056
					25RMC	Rapid Micro C	3628 000 0064
CS-3700ES, CS-370ES, CS-4200ES, CS-420ES, CS-4400, CS-450, CS-510, CS-5100	38/15	.325"	1,5	64	25RMC3	Rapid Micro C3	3633 000 0064
					25RSC	Rapid Super C	3638 000 0064
					25RMC	Rapid Micro C	3628 000 0064
					25RMC3	Rapid Micro C3	3633 000 0064
CS-4200ES, CS-420ES	43	.325"	1,5	72	25RSC	Rapid Super C	3638 000 0072
					25RMC	Rapid Micro C	3628 000 0072
					25RMC3	Rapid Micro C3	3633 000 0072
					25RSC	Rapid Super C	3638 000 0072
CS-396(SP), CS-4400, CS-450, CS-510, CS-5100	45/18	.325"	1,5	72	25RMC	Rapid Micro C	3628 000 0072
					25RMC3	Rapid Micro C3	3633 000 0072
					25RSC	Rapid Super C	3638 000 0072
					25RMC	Rapid Micro C	3628 000 0072
CS-600, CS-6702, CS-680, CS-6800, CS-680S, CS-8001, CS-8002	45/18	3/8"	1,5	64	35RMC	Rapid Micro C	3651 000 0064
					35RSC	Rapid Super C	3622 000 0064
CS-450, CS-510, CS-5100	50/20	.325"	1,5	80	25RMC	Rapid Micro C	3628 000 0080
					25RMC3	Rapid Micro C3	3633 000 0080
					25RSC	Rapid Super C	3638 000 0080



Модель	Длина	Шаг	Паз	Кол-во звеньев	Цепь	Полное название	Артикул
CS-600, CS-6702, CS-680, CS-6800, CS-680S, CS-8001, CS-8002	50/20	3/8"	1,5	72	35RMC	Rapid Micro C	3651 000 0072
					35RSC	Rapid Super C	3622 000 0072
CS-600, CS-6702, CS-680, CS-6800, CS-680S, CS-8001, CS-8002	60/24	3/8"	1,5	84	35RMC	Rapid Micro C	3651 000 0084
					35RSC	Rapid Super C	3622 000 0084
CS-8001, CS-8002	70/28	3/8"	1,5	96	35RMC	Rapid Micro C	3651 000 0096
					35RSC	Rapid Super C	3622 000 0096
CS-1201	90/36	.404"	1,6	104	46RM	Rapid Micro	3668 000 0104
					46RS	Rapid Super	3946 000 0104
					46RSK	Rapid Super K	3846 000 0104
					46RCK	Rapid Standard K	3812 000 0104

## EFCO

125, MT2600	25/10	1/4"	1,3	60	13RMC	Rapid Micro C	3660 000 0060
					13RMS	Rapid Micro Spezial	3661 000 0060
125, MT2600	25/10	3/8"	1,3	40	63PMC3	Picco Micro C3	3636 000 0040
					63PMC	Picco Micro C	3613 000 0040
					63PD3	Picco Duro	3612 000 0040
132S, 15E	30/12	3/8"	1,3	44	63PMC3	Picco Micro C3	3636 000 0044
					63PMC	Picco Micro C	3613 000 0044
					63PD3	Picco Duro	3612 000 0044
132S, 17E	35/14	3/8"	1,3	50	63PMC3	Picco Micro C3	3636 000 0050
					63PMC	Picco Micro C	3613 000 0050
					63PD3	Picco Duro	3612 000 0050
140S, 141S	40/16	3/8"	1,3	56	63PMC3	Picco Micro C3	3636 000 0056
					63PMC	Picco Micro C	3613 000 0056
					63PD3	Picco Duro	3612 000 0056
136, 137, 140, 19E, EF2000E, MT 350	40/16	3/8"	1,3	57	63PMC3	Picco Micro C3	3636 000 0057
					63PMC	Picco Micro C	3613 000 0057
					63PD3	Picco Duro	3612 000 0057
146, 147, 151, 152, 156, 162	40/16	.325"	1,5	66	25RMC	Rapid Micro C	3628 000 0066
					25RMC3	Rapid Micro C3	3633 000 0066
					25RSC	Rapid Super C	3638 000 0066
146, 147, 151, 152, 156, 162, 171, 181	45/18	.325"	1,5	72	25RMC	Rapid Micro C	3628 000 0072
					25RMC3	Rapid Micro C3	3633 000 0072
					25RSC	Rapid Super C	3638 000 0072
165HD	45/18	3/8"	1,5	68	35RMC	Rapid Micro C	3651 000 0068
					35RSC	Rapid Super C	3622 000 0068
146, 147, 151, 152, 156, 162, 171, 181	50/20	.325"	1,5	78	25RMC	Rapid Micro C	3628 000 0078
					25RMC3	Rapid Micro C3	3633 000 0078
					25RSC	Rapid Super C	3638 000 0078
171, 181, MT 7200	50/20	3/8"	1,5	72	35RMC	Rapid Micro C	3651 000 0072
					35RSC	Rapid Super C	3622 000 0072
171, 181, MT 7200, 185 HD	63/25	3/8"	1,5	88	35RMC	Rapid Micro C	3651 000 0088
					35RSC	Rapid Super C	3622 000 0088
185HD	75/30	3/8"	1,5	98	35RMC	Rapid Micro C	3651 000 0098
					35RSC	Rapid Super C	3622 000 0098
199	75/30	.404"	1,6	92	46RM	Rapid Micro	3668 000 0092
					46RS	Rapid Super	3946 000 0092

# Пильные цепи для моторных пил других марок

Модель	Длина	Шаг	Паз	Кол-во звеньев	Цепь	Полное название	Артикул
					46RSK	Rapid Super K	3846 000 0092
					46RCK	Rapid Standard K	3812 000 0092
<b>EINHELL</b>							
KSE 1435, KSE 1635, RBK 3735	35/14	3/8"	1,3	52	63PMC3	Picco Micro C3	3636 000 0052
					63PMC	Picco Micro C	3613 000 0052
					63PD3	Picco Duro	3612 000 0052
KSE 1640, KSE 2000, MKS 38/41, PKS 1840, REK 2040	40/16	3/8"	1,3	57	63PMC3	Picco Micro C3	3636 000 0057
					63PMC	Picco Micro C	3613 000 0057
					63PD3	Picco Duro	3612 000 0057
<b>HITACHI</b>							
CS 25EPB(S)	25/10	3/8"	1,1	40	61PMMC3	Picco Micro Mini C3	3610 000 0040
CS 25ES(SC)	25/10	1/4"	1,3	60	13RMC	Rapid Micro C	3660 000 0060
					13RMS	Rapid Micro Spezial	3661 000 0060
CS 25EC(S)	25/10	3/8"	1,3	40	63PMC3	Picco Micro C3	3636 000 0040
					63PMC	Picco Micro C	3613 000 0040
					63PD3	Picco Duro	3612 000 0040
CS 30EC(S), CS 30EG(S) CS 30 EH(S), CS 30EJ	30/12	3/8"	1,3	45	63PMC3	Picco Micro C3	3636 000 0045
					63PMC	Picco Micro C	3613 000 0045
					63PD3	Picco Duro	3612 000 0045
CS 33EL	33/13	.325"	1,3	56	23RMC	Rapid Micro C	3627 000 0056
					23RMC3	Rapid Micro C3	3632 000 0056
					23RSC	Rapid Super C	3637 000 0056
CS 33EB, CS 350A, CS 35EG(S), CS 35 EH(S), CS 35EJ	35/14	3/8"	1,3	52	63PMC3	Picco Micro C3	3636 000 0052
					63PMC	Picco Micro C	3613 000 0052
					63PD3	Picco Duro	3612 000 0052
CS 38EB, CS 38EK, CS 38EL	38/15	.325"	1,3	64	23RMC	Rapid Micro C	3627 000 0064
					23RMC3	Rapid Micro C3	3632 000 0064
					23RSC	Rapid Super C	3637 000 0064
CS 40EK, CS 40EL	40/16	.325"	1,3	66	23RMC	Rapid Micro C	3627 000 0066
					23RMC3	Rapid Micro C3	3632 000 0066
					23RSC	Rapid Super C	3637 000 0066
CS 45EK, CS 45EL	45/18	.325"	1,3	72	23RMC	Rapid Micro C	3627 000 0072
					23RMC3	Rapid Micro C3	3632 000 0072
CS 40EM	40/16	.325"	1,5	66	23RSC	Rapid Super C	3637 000 0072
					25RMC	Rapid Micro C	3628 000 0066
					25RMC3	Rapid Micro C3	3633 000 0066
					25RSC	Rapid Super C	3638 000 0066
CS 45EM	45/18	.325"	1,5	72	25RMC	Rapid Micro C	3628 000 0072
					25RMC3	Rapid Micro C3	3633 000 0072
					25RSC	Rapid Super C	3638 000 0072
<b>HOMELITE</b>							
CSP3314, HCS3535, CWE1814	35/14	3/8"	1,3	52	63PMC3	Picco Micro C3	3636 000 0052
					63PMC	Picco Micro C	3613 000 0052
					63PD3	Picco Duro	3612 000 0052
CSP4016 (C)	40/16	.325"	1,3	66	23RMC	Rapid Micro C	3627 000 0066
					23RMC3	Rapid Micro C3	3632 000 0066
					23RSC	Rapid Super C	3637 000 0066

Модель	Длина	Шаг	Паз	Кол-во звеньев	Цепь	Полное название	Артикул
CSP3316 (C), HCS4041, CWE2016	40/16	3/8"	1,3	57	63PMC3	Picco Micro C3	3636 000 0057
					63PMC	Picco Micro C	3613 000 0057
					63PD3	Picco Duro	3612 000 0057
CSP4518	45/18	.325"	1,3	72	23RMC	Rapid Micro C	3627 000 0072
					23RMC3	Rapid Micro C3	3632 000 0072
					23RSC	Rapid Super C	3637 000 0072
CSP4520	50/20	.325"	1,3	80	23RMC	Rapid Micro C	3627 000 0080
					23RMC3	Rapid Micro C3	3632 000 0080
					23RSC	Rapid Super C	3637 000 0080

## HUSQVARNA

323P4, 323P4x, .325"P5x	25/10	3/8"	1,1	40	61PMMC3	Picco Micro Mini C3	3610 000 0040
					61PMMC3	Picco Micro Mini C3	3610 000 0045
					63PMC3	Picco Micro C3	3636 000 0040
323P4, 323P4x, .325"P5x	30/12	3/8"	1,1	45	63PMC	Picco Micro C	3613 000 0040
					63PD3	Picco Duro	3612 000 0040
					63PMC3	Picco Micro C3	3636 000 0045
.325"P5x	25	3/8"	1,3	40	63PMC	Picco Micro C	3613 000 0040
					63PD3	Picco Duro	3612 000 0040
					63PMC3	Picco Micro C3	3636 000 0045
236, 317/321 Electric, .325"P5x, 334T, 335XPT, 338XPT	30/12	3/8"	1,3	45	63PMC	Picco Micro C	3613 000 0045
					63PD3	Picco Duro	3612 000 0045
					23RMC	Rapid Micro C	3627 000 0056
336, 355, 136, 137(e), 141, 142(e), 240e, 235e, 435, 351, 339XP, 340(e), 440(e), 345(e), 444, 445(e), 350, 450(e), 353, 346XP, 460, 357XP, 359, 55, 455(e) Rancher	33/13	.325"	1,3	56	23RMC3	Rapid Micro C3	3632 000 0056
					23RSC	Rapid Super C	3637 000 0056
					63PMC3	Picco Micro C3	3636 000 0052
236, 315, 316, 317, 318, 321 Electric, 334T, 335XPT, 338XPT	35/14	3/8"	1,3	52	63PMC	Picco Micro C	3613 000 0052
					63PD3	Picco Duro	3612 000 0052
					23RMC	Rapid Micro C	3627 000 0064
336, 355, 136, 137(e), 141, 142(e), 240e, 235e, 435, 351, 339XP, 340(e), 440(e), 345(e), 444, 445(e), 350, 450(e), 353, 346XP, 460, 357XP, 359, 55, 455(e) Rancher	38/15	.325"	1,3	64	23RMC3	Rapid Micro C3	3632 000 0064
					23RSC	Rapid Super C	3637 000 0064
					23RMC	Rapid Micro C	3627 000 0066
435, 336, 355, 339XP, 340(e), 440(e), 345(e), 444, 55, 445(e), 350, 450(e), 351, 353, 346XP, 460, 357XP, 359, 455(e) Rancher	40/16	.325"	1,3	66	23RMC3	Rapid Micro C3	3632 000 0066
					23RSC	Rapid Super C	3637 000 0066
					63PMC3	Picco Micro C3	3636 000 0056
236, 315, 316, 317, 318, 321 Electric, 335XPT, 338XPT	40/16	3/8"	1,3	56	63PMC	Picco Micro C	3613 000 0056
					63PD3	Picco Duro	3612 000 0056
					23RMC	Rapid Micro C	3627 000 0072
435, 355, 339XP, 340(e), 440(e), 345(e), 444, 445(e), 350, 450(e), 351, 353, 346XP, 460, 357XP, 359, 55, 455(e) Rancher	45/18	.325"	1,3	72	23RMC3	Rapid Micro C3	3632 000 0072
					23RSC	Rapid Super C	3637 000 0072
					23RMC	Rapid Micro C	3627 000 0080
355, 351, 353, 346XP, 460, 357XP, 359, 55, 455(e) Rancher	50/20	.325"	1,3	80	23RMC3	Rapid Micro C3	3632 000 0080
					23RSC	Rapid Super C	3637 000 0080
					25RMC	Rapid Micro C	3628 000 0056
355, 136, 137(e), 141, 142(e), 154, 234, 242(XP), 345(e), 254(XP), 257, 262(XP), 357, 240e, 235e, 340(e), 440(e), 444, 445(e), 350, 450(e), 351, 353, 346XP, 362(XP), 460, 357XP, 359, 55, 455(e) Rancher	33/13	.325"	1,5	56	25RMC3	Rapid Micro C3	3633 000 0056
					25RSC	Rapid Super C	3638 000 0056
					25RMC	Rapid Micro C	3628 000 0064
355, 136, 137(e), 141, 142(e), 154, 234, 242(XP), 345(e), 254(XP), 257, 262(XP), 357, 240e, 235e, 340(e), 440(e), 444, 445(e), 350, 450(e), 351, 353, 346XP, 362(XP), 460, 357XP, 359, 55, 455(e) Rancher	38/15	.325"	1,5	64	25RMC3	Rapid Micro C3	3633 000 0064
					25RSC	Rapid Super C	3638 000 0064
					25RMC	Rapid Micro C	3628 000 0064

# Пильные цепи для моторных пил других марок

Модель	Длина	Шаг	Паз	Кол-во звеньев	Цепь	Полное название	Артикул
154, 181, 234, 242(XP), 254(XP), 257, 262(XP), 357, 36, 40, 41, 42, 45, 51, 55, 365, 372XP, 362(XP), 460, 357XP, 359, 55, 455(e) Rancher, 570, 575XP, 576XP, 61, 268(XP), 272(XP), 288XP	38/15	3/8"	1,5	56	35RMC	Rapid Micro C	3651 000 0056
					35RSC	Rapid Super C	3622 000 0056
355, 136,137(e), 141, 142(e), 154, 234, 242(XP), 254(XP), 257, 262(XP), 357, 240e, 235e, 340(e), 440(e), 345(e), 444, 445(e), 350, 450(e), 351, 353, 346XP, 362(XP), 460, 357XP, 359, 55, 455(e) Rancher	40/16	.325"	1,5	66	25RMC	Rapid Micro C	3628 000 0066
					25RMC3	Rapid Micro C3	3633 000 0066
					25RSC	Rapid Super C	3638 000 0066
154, 181, 234, 242(XP), 254(XP), 257, 262(XP), 357, 36, 40, 41, 42, 45, 51, 55, 365, 372XP, 362(XP), 460, 357XP, 359, 55, 455(e) Rancher, 570, 575XP, 576XP, 61, 268(XP), 272(XP), 288XP	40/16	3/8"	1,5	60	35RMC	Rapid Micro C	3651 000 0060
					35RSC	Rapid Super C	3622 000 0060
355, 154, 234, 242(XP), 254(XP), 257, 262(XP), 357, 240e, 235e, 340(e), 440(e), 345(e), 444, 445(e), 350, 450(e), 351, 353, 346XP, 362(XP), 460, 357XP, 359, 55, 455(e) Rancher	45/18	.325"	1,5	72	25RMC	Rapid Micro C	3628 000 0072
					25RMC3	Rapid Micro C3	3633 000 0072
					25RSC	Rapid Super C	3638 000 0072
355, 154, 181, 234, 242(XP), 254(XP), 257, 262(XP), 357, 36, 40, 41, 42, 45, 51, 55, 365, 372XP, 362(XP), 385(XP), 390XP, 394XP, 395XP, 460, 357XP, 359, 55, 455(e) Rancher, 570, 575XP, 576XP, 61, 268(XP), 272(XP), 288XP	45/18	3/8"	1,5	68	35RMC	Rapid Micro C	3651 000 0068
					35RSC	Rapid Super C	3622 000 0068
355, 154, 234, 242(XP), 254(XP), 257, 262(XP), 357, 240e, 235e, 340(e), 440(e), 345(e), 444, 445(e), 350, 450(e), 351, 353, 346XP, 362(XP), 460, 357XP, 359, 55, 455(e) Rancher	50/20	.325"	1,5	80	25RMC	Rapid Micro C	3628 000 0080
					25RMC3	Rapid Micro C3	3633 000 0080
					25RSC	Rapid Super C	3638 000 0080
355, 154, 181, 234, 242(XP), 254(XP), 257, 262(XP), 357, 36, 40, 41, 42, 45, 51, 55, 365, 372XP, 362(XP), 385(XP), 390XP, 394XP, 395XP, 460, 357XP, 359, 55, 455(e) Rancher, 570, 575XP, 576XP, 61, 268(XP), 272(XP), 288XP	50/20	3/8"	1,5	72	35RMC	Rapid Micro C	3651 000 0072
					35RSC	Rapid Super C	3622 000 0072
355, 36, 40, 41, 42, 45, 51, 55, 365, 272XP, 372XP, 385(XP), 390XP, 394XP, 395XP, 570, 575XP	60/24	3/8"	1,5	84	35RMC	Rapid Micro C	3651 000 0084
					35RSC	Rapid Super C	3622 000 0084
355, 36, 40, 41, 42, 45, 51, 55, 365, 272XP, 372XP, 576XP, 385(XP), 390XP, 394XP, 395XP, 570, 575XP	72/29	3/8"	1,5	92	35RMC	Rapid Micro C	3651 000 0092
					35RSC	Rapid Super C	3622 000 0092
3120XP, 390XP, 394XP, 395XP	60/24	.404"	1,6	76	46RM	Rapid Micro	3668 000 0076
					46RS	Rapid Super	3946 000 0076
					46RSK	Rapid Super K	3846 000 0076
					46RCK	Rapid Standard K	3812 000 0076
3120XP, 390XP, 394XP, 395XP	72/29	.404"	1,6	84	46RM	Rapid Micro	3668 000 0084
					46RS	Rapid Super	3946 000 0084
					46RSK	Rapid Super K	3846 000 0084
					46RCK	Rapid Standard K	3812 000 0084
3120XP, 390XP, 394XP, 395XP	75/30	.404"	1,6	92	46RM	Rapid Micro	3668 000 0092
					46RS	Rapid Super	3946 000 0092
					46RSK	Rapid Super K	3846 000 0092
					46RCK	Rapid Standard K	3812 000 0092
3120XP, 390XP, 394XP, 395XP	90/36	.404"	1,6	104	46RM	Rapid Micro	3668 000 0104
					46RS	Rapid Super	3946 000 0104

Модель	Длина	Шаг	Паз	Кол-во звеньев	Цепь	Полное название	Артикул
3120XP	105/42	.404"	1,6	124	46RSK	Rapid Super K	3846 000 0104
					46RCK	Rapid Standard K	3812 000 0104
					46RM	Rapid Micro	3668 000 0124
					46RS	Rapid Super	3946 000 0124
					46RSK	Rapid Super K	3846 000 0124
					46RCK	Rapid Standard K	3812 000 0124

## JONSERED

2035, CS 2139 T, CS 2117 EL, CS 2121 EL, CS 2137, CS 2138	30/12	3/8"	1,3	45	63PMC3	Picco Micro C3	3636 000 0045
CS 2147	33/13	.325"	1,3	56	63PMC	Picco Micro C	3613 000 0045
					63PD3	Picco Duro	3612 000 0045
					23RMC	Rapid Micro C	3627 000 0056
2035, CS 2139 T, CS 2117 EL, CS 2121 EL, CS 2137, CS 2138	35/14	3/8"	1,3	52	23RMC3	Rapid Micro C3	3632 000 0056
					23RSC	Rapid Super C	3637 000 0056
					63PMC3	Picco Micro C3	3636 000 0052
CS 2147	38/15	.325"	1,3	64	63PMC	Picco Micro C	3613 000 0052
					63PD3	Picco Duro	3612 000 0052
					23RMC	Rapid Micro C	3627 000 0064
2035, CS 2139 T, CS 2117 EL, CS 2121 EL, CS 2137, CS 2138	40/16	3/8"	1,3	56	23RMC3	Rapid Micro C3	3632 000 0064
					23RSC	Rapid Super C	3637 000 0064
					63PMC3	Picco Micro C3	3636 000 0056
CS 2147	45/18	.325"	1,3	72	63PMC	Picco Micro C	3613 000 0056
					63PD3	Picco Duro	3612 000 0056
					23RMC	Rapid Micro C	3627 000 0072
2035, CS 2139 T, CS 2117 EL, CS 2121 EL, CS 2137, CS 2138	45/18	3/8"	1,3	60	23RMC3	Rapid Micro C3	3632 000 0072
					23RSC	Rapid Super C	3637 000 0072
					63PMC3	Picco Micro C3	3636 000 0060
2012 EL, 2014 EL, 2015 EL, 2016 EL, 2036, 2040, 2041, 2045, 2050, 2051, 2054, 2055, CS 2141, CS 2145 S, CS 2150, CS 2152, CS 2153	28/11	.325"	1,5	52	63PMC	Picco Micro C	3613 000 0060
					63PD3	Picco Duro	3612 000 0060
					25RMC	Rapid Micro C	3628 000 0052
2012 EL, 2014 EL, 2015 EL, 2016 EL, 2036, 2040, 2041, 2045, 2050, 2051, 2054, 2055, CS 2141, CS 2145 S, CS 2150, CS 2152, CS 2153	33/13	.325"	1,5	56	25RMC3	Rapid Micro C3	3633 000 0052
					25RSC	Rapid Super C	3638 000 0052
					25RMC	Rapid Micro C	3628 000 0056
2065, 2071, 2095, CS 2165, CS 2171, CS 2186	33/13	3/8"	1,5	52	25RMC3	Rapid Micro C3	3633 000 0056
					25RSC	Rapid Super C	3638 000 0056
					35RMC	Rapid Micro C	3651 000 0052
2014 EL, 2014 EL, 2015 EL, 2016 EL, 2036, 2040, 2041, 2045, 2050, 2051, 2054, 2055, CS 2141, CS 2145 S, CS 2150, CS 2152, CS 2153	35/14	.325"	1,5	60	35RSC	Rapid Super C	3622 000 0052
					25RMC	Rapid Micro C	3628 000 0060
					25RMC3	Rapid Micro C3	3633 000 0060
2012 EL, 2014 EL, 2015 EL, 2016 EL, 2036, 2040, 2041, 2045, 2050, 2051, 2054, 2055, CS 2141, CS 2145 S, CS 2150, CS 2152, CS 2153	38/15	.325"	1,5	64	25RSC	Rapid Super C	3638 000 0060
					25RMC	Rapid Micro C	3628 000 0064
					25RMC3	Rapid Micro C3	3633 000 0064
2065, 2071, 2095, CS 2165, CS 2171, CS 2186	38/15	3/8"	1,5	56	25RSC	Rapid Super C	3638 000 0064
					35RMC	Rapid Micro C	3651 000 0056
					35RSC	Rapid Super C	3622 000 0056
2012 EL, 2014 EL, 2015 EL, 2016 EL, 2036, 2040, 2041, 2045, 2050, 2051, 2054, 2055, CS 2141, CS 2145 S, CS 2150, CS 2152, CS 2153	40/16	.325"	1,5	66	25RMC	Rapid Micro C	3628 000 0066
					25RMC3	Rapid Micro C3	3633 000 0066
					25RSC	Rapid Super C	3638 000 0066

# Пильные цепи для моторных пил других марок

Модель	Длина	Шаг	Паз	Кол-во звеньев	Цепь	Полное название	Артикул
2012 EL, 2014 EL, 2015 EL, 2016 EL, 2036, 2040, 2041, 2045, 2050, 2051, 2054, 2055, CS 2141, CS 2145 S, CS 2150, CS 2152, CS 2153	45/18	.325"	1,5	72	25RMC	Rapid Micro C	3628 000 0072
					25RMC3	Rapid Micro C3	3633 000 0072
					25RSC	Rapid Super C	3638 000 0072
2065, 2071, 2095, CS 2165, CS 2171, CS 2186	45/18	3/8"	1,5	68	35RMC	Rapid Micro C	3651 000 0068
					35RSC	Rapid Super C	3622 000 0068
					25RMC	Rapid Micro C	3628 000 0078
2012 EL, 2014 EL, 2015 EL, 2016 EL, 2036, 2040, 2041, 2045, 2050, 2051, 2054, 2055, CS 2141, CS 2145 S, CS 2150, CS 2152, CS 2153	50/20	.325"	1,5	78	25RMC3	Rapid Micro C3	3633 000 0078
					25RSC	Rapid Super C	36380000078
					35RMC	Rapid Micro C	3651 000 0072
2065, 2071, 2095, CS 2165, CS 2171, CS 2186	50/20	3/8"	1,5	72	35RSC	Rapid Super C	3622 000 0072
					35RMC	Rapid Micro C	3651 000 0072
2065, 2071, 2095, CS 2165, CS 2171, CS 2186	55/22	3/8"	1,5	76	35RSC	Rapid Super C	3622 000 0076
					35RMC	Rapid Micro C	3651 000 0076
2065, 2071, 2095, CS 2165, CS 2171, CS 2186	60/24	3/8"	1,5	84	35RSC	Rapid Super C	3622 000 0084
					35RMC	Rapid Micro C	3651 000 0084
2065, 2071, 2095, CS 2165, CS 2171, CS 2186	70/28	3/8"	1,5	92	35RSC	Rapid Super C	3622 000 0092
					35RMC	Rapid Micro C	3651 000 0092
2065, 2071, 2095, CS 2165, CS 2171, CS 2186	75/30	3/8"	1,5	102	35RSC	Rapid Super C	3622 000 0102
					35RMC	Rapid Micro C	3651 000 0102
<b>МАКИТА</b>							
DCS34, UC3010A	30/12	3/8"	1,1	46	61PMMC3	Picco Micro Mini C3	3610 000 0046
DCS34, UC3010A	35/14	3/8"	1,1	52	61PMMC3	Picco Micro Mini C3	3610 000 0052
UC4010A	40/16	3/8"	1,1	56	61PMMC3	Picco Micro Mini C3	3610 000 0056
DCS330TH	25/10	3/8"	1,3	42	63PMC3	Picco Micro C3	3636 000 0042
					63PMC	Picco Micro C	3613 000 0042
					63PD3	Picco Duro	3612 000 0042
DCS230(T)	25/10	3/8"	1,3	40	63PMC3	Picco Micro C3	3636 000 0040
					63PMC	Picco Micro C	3613 000 0040
					63PD3	Picco Duro	3612 000 0040
5012B, 5014NB, 5016NB	30/12	3/8"	1,3	45	63PMC3	Picco Micro C3	3636 000 0045
					63PMC	Picco Micro C	3613 000 0045
					63PD3	Picco Duro	3612 000 0045
UC3001A, UC3003A, DCS330TH, DCS3400TH, UC3020A, UC3030A, DCS3500, DCS3410TH	30/12	3/8"	1,3	46	63PMC3	Picco Micro C3	3636 000 0046
					63PMC	Picco Micro C	3613 000 0046
					63PD3	Picco Duro	3612 000 0046
DCS420, DCS4300, DCS4301	33/13	.325"	1,3	56	23RMC	Rapid Micro C	3627 000 0056
					23RMC3	Rapid Micro C3	3632 000 0056
					23RSC	Rapid Super C	3637 000 0056
DCS33, DCS34, DCS330TH, DCS340, DCS341, UC3501A, UC3503A, UC3520A, UC3530A, DCS3500, DCS3410TH, 5012B, 5014NB, 5016NB	35/14	3/8"	1,3	52	63PMC3	Picco Micro C3	3636 000 0052
					63PMC	Picco Micro C	3613 000 0052
					63PD3	Picco Duro	3612 000 0052
DCS420, DCS4300, DCS4301	38/15	.325"	1,3	64	23RMC	Rapid Micro C	3627 000 0064
					23RMC3	Rapid Micro C3	3632 000 0064
					23RSC	Rapid Super C	3637 000 0064
DCS400, DCS401, UC4001A, UC4003A, UC4020A, UC4030A, DCS3500	40/16	3/8"	1,3	56	63PMC3	Picco Micro C3	3636 000 0056
					63PMC	Picco Micro C	3613 000 0056
					63PD3	Picco Duro	3612 000 0056
5012B, 5014NB, 5016NB	40/16	3/8"	1,3	57	63PMC3	Picco Micro C3	3636 000 0057
					63PMC	Picco Micro C	3613 000 0057

Модель	Длина	Шаг	Паз	Кол-во звеньев	Цепь	Полное название	Артикул
DCS420, DCS4300, DCS4301	45/18	.325"	1,3	72	63PD3	Picco Duro	3612 000 0057
					23RMC	Rapid Micro C	3627 000 0072
					23RMC3	Rapid Micro C3	3632 000 0072
					23RSC	Rapid Super C	3637 000 0072
UC4503A, UC4530A	45/18	3/8"	1,3	62	63PMC3	Picco Micro C3	3636 000 0062
					63PMC	Picco Micro C	3613 000 0062
					63PD3	Picco Duro	3612 000 0062
DCS520, DCS4600S, DCS5000, DCS5200I, DCS6000, DCS6001, DCS6800I	38/15	3/8"	1,5	56	35RMC	Rapid Micro C	3651 000 0056
					35RSC	Rapid Super C	3622 000 0056
DCS430, DCS431, DCS520, DCS4600S, DCS5000, DCS5200I, DCS6001, DCS6800I	45/18	3/8"	1,5	64	35RMC	Rapid Micro C	3651 000 0064
					35RSC	Rapid Super C	3622 000 0064
DCS6400, DCS6401	45/18	3/8"	1,5	68	35RMC	Rapid Micro C	3651 000 0068
					35RSC	Rapid Super C	3622 000 0068
DCS5000, DCS6000I, DCS6001, CS6400, DCS 6401, DCS6800I, DCS7300, DCS 7301, DCS7900, DCS7901, DCS9000, DCS9010	50/20	3/8"	1,5	72	35RMC	Rapid Micro C	3651 000 0072
					35RSC	Rapid Super C	3622 000 0072
DCS6800I, DCS9000, DCS9010	60/24	3/8"	1,5	80	35RMC	Rapid Micro C	3651 000 0080
					35RSC	Rapid Super C	3622 000 0080
DCS7300, DCS 7301, DCS7900, DCS7901	60/24	3/8"	1,5	83	35RMC	Rapid Micro C	3651 000 0083
					35RSC	Rapid Super C	3622 000 0083
DCS9000	74/30	3/8"	1,5	96	35RMC	Rapid Micro C	3651 000 0096
					35RSC	Rapid Super C	3622 000 0096

## MCCULLOCH

Mac 538, Mac 539, Mac 540, Mac 542, Mac 545, MacCat 436, MacCat 438, ProMac 33	30/12	3/8"	1,3	45	63PMC3	Picco Micro C3	3636 000 0045
					63PMC	Picco Micro C	3613 000 0045
					63PD3	Picco Duro	3612 000 0045
Elektramac 312, Elektramac 330, Mac 930	30/12	3/8"	1,3	46	63PMC3	Picco Micro C3	3636 000 0046
					63PMC	Picco Micro C	3613 000 0046
					63PD3	Picco Duro	3612 000 0046
ProMac 46	33/13	.325"	1,3	56	23RMC	Rapid Micro C	3627 000 0056
					23RMC3	Rapid Micro C3	3632 000 0056
					23RSC	Rapid Super C	3637 000 0056
					63PMC3	Picco Micro C3	3636 000 0050
Mac 538, Mac 539, Mac 540, Mac 542, Mac 545, MacCat 436, MacCat 438, ProMac 33	35/14	3/8"	1,3	50	63PMC	Picco Micro C	3613 000 0050
					63PD3	Picco Duro	3612 000 0050
					63PMC3	Picco Micro C3	3636 000 0052
InLine 1650, InLine 1800T, Mac 738, Elektramac 235, E ProMac 1900, Elektramac 314, Elektramac 335, Elektramac 414, Titanium 735, Mac 935, 3205AV	35/14	3/8"	1,3	52	63PMC	Picco Micro C	3613 000 0052
					63PD3	Picco Duro	3612 000 0052
					63PMC3	Picco Micro C3	3636 000 0064
ProMac 46	38/15	.325"	1,3	64	23RMC	Rapid Micro C	3627 000 0064
					23RMC3	Rapid Micro C3	3632 000 0064
					23RSC	Rapid Super C	3637 000 0064
Titanium 420, Titanium 460	40/16	.325"	1,3	66	23RMC	Rapid Micro C	3627 000 0066
					23RMC3	Rapid Micro C3	3632 000 0066
					23RSC	Rapid Super C	3637 000 0066
Mac 538, Mac 539, Mac 540, Mac 542, Mac 545, MacCat 436, MacCat 438, ProMac 33, Titanium 740, Mac 940, 3505AV	40/16	3/8"	1,3	55	63PMC3	Picco Micro C3	3636 000 0055
					63PMC	Picco Micro C	3613 000 0055
					63PD3	Picco Duro	3612 000 0055

# Пильные цепи для моторных пил других марок

Модель	Длина	Шаг	Паз	Кол-во звеньев	Цепь	Полное название	Артикул
Mac .325", Mac 335, MacCat 438, MacCat 440, MacCat 441, Mac 740, Mac 842, Elektramac 316, Elektramac 340, Elektramac 416, Mac 444	40/16	3/8"	1,3	56	63PMC3	Picco Micro C3	3636 000 0056
					63PMC	Picco Micro C	3613 000 0056
					63PD3	Picco Duro	3612 000 0056
ProMac 46, Titanium 420, Titanium 460	45/18	.325"	1,3	72	23RMC	Rapid Micro C	3627 000 0072
					23RMC3	Rapid Micro C3	3632 000 0072
					23RSC	Rapid Super C	3637 000 0072
Mac 538, Mac 539, Mac 540, Mac 542, Mac 545, MacCat 436, MacCat 438, ProMac 33, California 2000, California 90, 3805AV	45/18	3/8"	1,3	60	63PMC3	Picco Micro C3	3636 000 0060
					63PMC	Picco Micro C	3613 000 0060
					63PD3	Picco Duro	3612 000 0060
MacCat 442	45/18	3/8"	1,3	62	63PMC3	Picco Micro C3	3636 000 0062
					63PMC	Picco Micro C	3613 000 0062
					63PD3	Picco Duro	3612 000 0062
ProMac 60, ProMac 61, ProMac 70, ProMac 72	33/13	3/8"	1,5	52	35RMC	Rapid Micro C	3651 000 0052
					35RSC	Rapid Super C	3622 000 0052
ProMac 60, ProMac 61, ProMac 70, ProMac 72	38/15	3/8"	1,5	56	35RMC	Rapid Micro C	3651 000 0056
					35RSC	Rapid Super C	3622 000 0056
ProMac 54, ProMac 55, ProMac 60, ProMac 61, ProMac 70, ProMac 72	40/16	3/8"	1,5	60	35RMC	Rapid Micro C	3651 000 0060
					35RSC	Rapid Super C	3622 000 0060
ProMac 54, ProMac 55, ProMac 60, ProMac 61, ProMac 70, ProMac 72	45/18	3/8"	1,5	68	35RMC	Rapid Micro C	3651 000 0068
					35RSC	Rapid Super C	3622 000 0068
ProMac 54, ProMac 55, ProMac 60, ProMac 61, ProMac 70, ProMac 72	50/20	3/8"	1,5	72	35RMC	Rapid Micro C	3651 000 0072
					35RSC	Rapid Super C	3622 000 0072
<b>OLEO-MAC</b>							
EP 90, EP 100, EP 120, PP 250, PPX 250	25/10	3/8"	1,1	39	61PMMC3	Picco Micro Mini C3	3610 000 0039
OM 15 E	35/14	3/8"	1,1	52	61PMMC3	Picco Micro Mini C3	3610 000 0052
925, 932 CK	25/10	1/4"	1,3	60	13RMC	Rapid Micro C	3660 000 0060
					13RMS	Rapid Micro Spezial	3661 000 0060
925	25/10	3/8"	1,3	40	63PMC3	Picco Micro C3	3636 000 0040
					63PMC	Picco Micro C	3613 000 0040
					63PD3	Picco Duro	3612 000 0040
OM 15 E, 932 C, 936, 940	30/12	3/8"	1,3	45	63PMC3	Picco Micro C3	3636 000 0045
					63PMC	Picco Micro C	3613 000 0045
					63PD3	Picco Duro	3612 000 0045
935 DX	30/12	3/8"	1,3	44	63PMC3	Picco Micro C3	3636 000 0044
					63PMC	Picco Micro C	3613 000 0044
					63PD3	Picco Duro	3612 000 0044
940 C	33/13	.325"	1,3	56	23RMC	Rapid Micro C	3627 000 0064
					23RMC3	Rapid Micro C3	3632 000 0064
					23RSC	Rapid Super C	3637 000 0064
E 140 F, E 160 F, 935 DX	35/14	3/8"	1,3	49	63PMC3	Picco Micro C3	3636 000 0049
					63PMC	Picco Micro C	3613 000 0049
					63PD3	Picco Duro	3612 000 0049
GS 940, OM 17 E, OM 19 E, 932 C, 936, 937, 940, GS 370, GS 410	35/14	3/8"	1,3	52	63PMC3	Picco Micro C3	3636 000 0052
					63PMC	Picco Micro C	3613 000 0052
					63PD3	Picco Duro	3612 000 0052
938, 941	38/15	.325"	1,3	64	23RMC	Rapid Micro C	3627 000 0064
					23RMC3	Rapid Micro C3	3632 000 0064
					23RSC	Rapid Super C	3637 000 0064



Модель	Длина	Шаг	Паз	Кол-во звеньев	Цепь	Полное название	Артикул
E 170	40/16	.325"	1,3	64	23RMC	Rapid Micro C	3627 000 0064
					23RMC3	Rapid Micro C3	3632 000 0064
					23RSC	Rapid Super C	3637 000 0064
938, 940 C, 941, 941 CX	40/16	.325"	1,3	66	23RMC	Rapid Micro C	3627 000 0066
					23RMC3	Rapid Micro C3	3632 000 0066
					23RSC	Rapid Super C	3637 000 0066
E 140 F, E 160 F, 935 DX	40/16	3/8"	1,3	56	63PMC3	Picco Micro C3	3636 000 0056
					63PMC	Picco Micro C	3613 000 0056
					63PD3	Picco Duro	3612 000 0056
GS 940, OM 17 E, OM 19 E, 932 C, 936, 937, 940, 941C, GS 370, GS 410, 1800E, 2000E	40/16	3/8"	1,3	57	63PMC3	Picco Micro C3	3636 000 0057
					63PMC	Picco Micro C	3613 000 0057
					63PD3	Picco Duro	3612 000 0057
952, 956	33/13	.325"	1,5	56	25RMC	Rapid Micro C	3628 000 0056
					25RMC3	Rapid Micro C3	3633 000 0056
					25RSC	Rapid Super C	3638 000 0056
942, 946, 947, 951, 952, 956, 962	40/16	.325"	1,5	66	25RMC	Rapid Micro C	3628 000 0066
					25RMC3	Rapid Micro C3	3633 000 0066
					25RSC	Rapid Super C	3638 000 0066
350, 261 GS, 264, 481, 482, E 300 F, 956, 962, 965 HD	40/16	3/8"	1,5	60	35RMC	Rapid Micro C	3651 000 0060
					35RSC	Rapid Super C	3622 000 0060
942, 946, 947, 951, 952, 956, 962	45/18	.325"	1,5	72	25RMC	Rapid Micro C	3628 000 0072
					25RMC3	Rapid Micro C3	3633 000 0072
					25RSC	Rapid Super C	3638 000 0072
350, 261 GS, 264, 481, 482, E 300 F, 956, 962, 965 HD	45/18	3/8"	1,5	68	35RMC	Rapid Micro C	3651 000 0068
					35RSC	Rapid Super C	3622 000 0068
956, 962	50/20	.325"	1,5	78	25RMC	Rapid Micro C	3628 000 0078
					25RMC3	Rapid Micro C3	3633 000 0078
					25RSC	Rapid Super C	3638 000 0078
350, 261 GS, 264, 481, 482, E 300 F, 956, 962, 965 HD, 970, 971, 980, 981, 985 HD	50/20	3/8"	1,5	72	35RMC	Rapid Micro C	3651 000 0072
					35RSC	Rapid Super C	3622 000 0072
965 HD, 970, 971, 980, 981, 985 HD	55/22	3/8"	1,5	77	35RMC	Rapid Micro C	3651 000 0077
					35RSC	Rapid Super C	3622 000 0077
970, 971, 980, 981, 985 HD	58/23	3/8"	1,5	80	35RMC	Rapid Micro C	3651 000 0080
					35RSC	Rapid Super C	3622 000 0080
970, 971, 980, 981, 985 HD	60/24	3/8"	1,5	84	35RMC	Rapid Micro C	3651 000 0084
					35RSC	Rapid Super C	3622 000 0084
350, 261 GS, 264, 481, 482, GS 820	75/30	3/8"	1,5	98	35RMC	Rapid Micro C	3651 000 0098
					35RSC	Rapid Super C	3622 000 0098
999 (F)	53/21	.404"	1,6	68	46RM	Rapid Micro	3668 000 0068
					46RS	Rapid Super	3946 000 0068
					46RSK	Rapid Super K	3846 000 0068
					46RCK	Rapid Standard K	3812 000 0068
999 (F)	63/25	.404"	1,6	80	46RM	Rapid Micro	3668 000 0080
					46RS	Rapid Super	3946 000 0080
					46RSK	Rapid Super K	3846 000 0080
					46RCK	Rapid Standard K	3812 000 0080
999 (F)	75/30	.404"	1,6	92	46RM	Rapid Micro	3668 000 0092
					46RS	Rapid Super	3946 000 0092

# Пильные цепи для моторных пил других марок

Модель	Длина	Шаг	Паз	Кол-во звеньев	Цепь	Полное название	Артикул
999 (F)	90/36	.404"	1,6	108	46RSK	Rapid Super K	3846 000 0092
					46RCK	Rapid Standard K	3812 000 0092
					46RM	Rapid Micro	3668 000 0108
					46RS	Rapid Super	3946 000 0108
					46RSK	Rapid Super K	3846 000 0108
999 (F)	103/41	.404"	1,6	123	46RCK	Rapid Standard K	3812 000 0108
					46RM	Rapid Micro	3668 000 0123
					46RS	Rapid Super	3946 000 0123
					46RSK	Rapid Super K	3846 000 0123
					46RCK	Rapid Standard K	3812 000 0123
<b>PARTNER</b>							
350, 351, 352, 370, 371, 382, 390, Formula 400, 401, 420, 421, 422, Formula 60, 842	30/12	3/8"	1,3	45	63PMC3	Picco Micro C3	3636 000 0045
450, 461, 462, 510, 511, 538, 540, 543, 4200, 4600, 4900, 5200	33/13	.325"	1,3	56	63PMC	Picco Micro C	3613 000 0045
					63PD3	Picco Duro	3612 000 0045
					23RMC	Rapid Micro C	3627 000 0056
1535	35/14	3/8"	1,3	50	23RMC3	Rapid Micro C3	3632 000 0056
					23RSC	Rapid Super C	3637 000 0056
					63PMC3	Picco Micro C3	3636 000 0050
350, 351, 352, 370, 371, 382, 390, Formula 400, 401, 420, 421, 422, Formula 60, 842	35/14	3/8"	1,3	52	63PMC	Picco Micro C	3613 000 0050
					63PD3	Picco Duro	3612 000 0050
					63PMC3	Picco Micro C3	3636 000 0052
450, 461, 462, 510, 511, 538, 540, 543, 4200, 4600, 4900, 5200	38/15	.325"	1,3	64	63PMC	Picco Micro C	3613 000 0052
					63PD3	Picco Duro	3612 000 0052
					23RMC	Rapid Micro C	3627 000 0064
1640, ES 2200, 2116	40/16	3/8"	1,3	54	23RMC3	Rapid Micro C3	3632 000 0064
					23RSC	Rapid Super C	3637 000 0064
					63PMC3	Picco Micro C3	3636 000 0054
350, 351, 352, 370, 371, 382, 390, Formula 400, 401, 420, 421, 422, Formula 60, 842	40/16	3/8"	1,3	56	63PMC	Picco Micro C	3613 000 0054
					63PD3	Picco Duro	3612 000 0054
					63PMC3	Picco Micro C3	3636 000 0056
450, 461, 462, 510, 511, 538, 540, 543, 4200, 4600, 4900, 5200	45/18	.325"	1,3	72	63PMC	Picco Micro C	3613 000 0056
					63PD3	Picco Duro	3612 000 0056
					23RMC	Rapid Micro C	3627 000 0072
350, 351, 352, 370, 371, 382, 390, Formula 400, 401, 420, 421, 422, Formula 60, 842	45/18	3/8"	1,3	62	23RMC3	Rapid Micro C3	3632 000 0072
					23RSC	Rapid Super C	3637 000 0072
					63PMC3	Picco Micro C3	3636 000 0062
450, 461, 462, 510, 511, 538, 540, 543, 4200, 4600, 4900, 5200	33/13	.325"	1,5	56	63PMC	Picco Micro C	3613 000 0062
					63PD3	Picco Duro	3612 000 0062
					25RMC	Rapid Micro C	3628 000 0056
450, 461, 462, 510, 511, 538, 540, 543, 4200, 4600, 4900, 5200	38/15	.325"	1,5	64	25RMC3	Rapid Micro C3	3633 000 0056
					25RSC	Rapid Super C	3638 000 0056
					25RMC	Rapid Micro C	3628 000 0064
450, 461, 462, 510, 511, 538, 540, 543, 4200, 4600, 4900, 5200	45/18	.325"	1,5	72	25RMC3	Rapid Micro C3	3633 000 0064
					25RSC	Rapid Super C	3638 000 0064
					25RMC	Rapid Micro C	3628 000 0072
450, 461, 462, 510, 511, 538, 540, 543, 4200, 4600, 4900, 5200	45/18	.325"	1,5	72	25RMC3	Rapid Micro C3	3633 000 0072
					25RSC	Rapid Super C	3638 000 0072
					25RMC	Rapid Micro C	3628 000 0072

Модель	Длина	Шаг	Паз	Кол-во звеньев	Цепь	Полное название	Артикул
450, 461, 462, 510, 511, 538, 540, 543, 4200, 4600, 4900, 5200	50/20	.325"	1,5	78	25RMC	Rapid Micro C	3628 000 0078
					25RMC3	Rapid Micro C3	3633 000 0078
					25RSC	Rapid Super C	3638 000 0078

## POULAN

1950, 2150, 2250, 2550	35/14	3/8"	1,3	52	63PMC3	Picco Micro C3	3636 000 0052
					63PMC	Picco Micro C	3613 000 0052
					63PD3	Picco Duro	3612 000 0052
1950, 2150, 2250, 2550	40/16	3/8"	1,3	57	63PMC3	Picco Micro C3	3636 000 0057
					63PMC	Picco Micro C	3613 000 0057
					63PD3	Picco Duro	3612 000 0057
1950, 2150, 2250, 2550	45/18	3/8"	1,3	66	63PMC3	Picco Micro C3	3636 000 0066
					63PMC	Picco Micro C	3613 000 0066
					63PD3	Picco Duro	3612 000 0066
PP4218AV, PP260	45/18	.325"	1,5	72	25RMC	Rapid Micro C	3628 000 0072
					25RMC3	Rapid Micro C3	3633 000 0072
					25RSC	Rapid Super C	3638 000 0072
PP295, PP4620	50/20	.325"	1,5	78	25RMC	Rapid Micro C	3628 000 0078
					25RMC3	Rapid Micro C3	3633 000 0078
					25RSC	Rapid Super C	3638 000 0078

## RYOBI

RELS-1800, PCN-3335, RCS-3335, RCS-3535C2, ECW-1835	35/14	3/8"	1,3	52	63PMC3	Picco Micro C3	3636 000 0052
					63PMC	Picco Micro C	3613 000 0052
					63PD3	Picco Duro	3612 000 0052
PCN-4040	40/16	.325"	1,3	66	23RMC	Rapid Micro C	3627 000 0066
					23RMC3	Rapid Micro C3	3632 000 0066
					23RSC	Rapid Super C	3637 000 0066
RELS-2000, RCS-3540C, RCS-4040C2, ECW-2040	40/16	3/8"	1,3	57	63PMC3	Picco Micro C3	3636 000 0057
					63PMC	Picco Micro C	3613 000 0057
					63PD3	Picco Duro	3612 000 0057
PCN-4545	45/18	.325"	1,3	72	23RMC	Rapid Micro C	3627 000 0072
					23RMC3	Rapid Micro C3	3632 000 0072
					23RSC	Rapid Super C	3637 000 0072
RCS-40406C, RCS-4446C2	45/18	3/8"	1,3	62	63PMC3	Picco Micro C3	3636 000 0062
					63PMC	Picco Micro C	3613 000 0062
					63PD3	Picco Duro	3612 000 0062

## SHINDAIWA

P230S	25/10	3/8"	1,1	39	61PMMC3	Picco Micro Mini C3	3610 000 0039
P230S	30/12	3/8"	1,1	44	61PMMC3	Picco Micro Mini C3	3610 000 0044
P230S	35/14	3/8"	1,1	50	61PMMC3	Picco Micro Mini C3	3610 000 0050
269T	25/10	3/8"	1,3	40	63PMC3	Picco Micro C3	3636 000 0040
					63PMC	Picco Micro C	3613 000 0040
					63PD3	Picco Duro	3612 000 0040
269T, 285, 300, 352, 357, 360	30/12	3/8"	1,3	45	63PMC3	Picco Micro C3	3636 000 0045
					63PMC	Picco Micro C	3613 000 0045
					63PD3	Picco Duro	3612 000 0045
269T, 285, 300, 352, 357, 360	35/14	3/8"	1,3	52	63PMC3	Picco Micro C3	3636 000 0052
					63PMC	Picco Micro C	3613 000 0052

# Пильные цепи для моторных пил других марок

Модель	Длина	Шаг	Паз	Кол-во звеньев	Цепь	Полное название	Артикул
360, 377, 389, 394, 446, 452, 488, 490	40/16	.325"	1,3	66	63PD3	Picco Duro	3612 000 0052
					23RMC	Rapid Micro C	3627 000 0066
					23RMC3	Rapid Micro C3	3632 000 0066
					23RSC	Rapid Super C	3637 000 0066
285, 300, 352, 357, 360	40/16	3/8"	1,3	57	63PMC3	Picco Micro C3	3636 000 0057
					63PMC	Picco Micro C	3613 000 0057
					63PD3	Picco Duro	3612 000 0057
360, 377, 389, 394, 446, 452, 488, 490	45/18	.325"	1,3	72	23RMC	Rapid Micro C	3627 000 0072
					23RMC3	Rapid Micro C3	3632 000 0072
					23RSC	Rapid Super C	3637 000 0072
360, 377, 389, 394, 446, 452, 488, 490	38/15	.325"	1,5	64	25RMC	Rapid Micro C	3628 000 0064
					25RMC3	Rapid Micro C3	3633 000 0064
					25RSC	Rapid Super C	3638 000 0064
360, 377, 389, 394, 446, 452, 488, 490	40/16	.325"	1,5	66	25RMC	Rapid Micro C	3628 000 0066
					25RMC3	Rapid Micro C3	3633 000 0066
					25RSC	Rapid Super C	3638 000 0066
577, 757	40/16	3/8"	1,5	60	35RMC	Rapid Micro C	3651 000 0060
577, 757	43/17	3/8"	1,5	64	35RSC	Rapid Super C	3622 000 0060
					35RMC	Rapid Micro C	3651 000 0064
360, 377, 389, 394, 446, 452, 488, 490	45/18	.325"	1,5	72	35RSC	Rapid Super C	3622 000 0064
					25RMC	Rapid Micro C	3628 000 0072
					25RMC3	Rapid Micro C3	3633 000 0072
577, 757	45/18	3/8"	1,5	68	25RSC	Rapid Super C	3638 000 0072
					35RMC	Rapid Micro C	3651 000 0068
					35RSC	Rapid Super C	3622 000 0068
577, 757	50/20	3/8"	1,5	72	35RMC	Rapid Micro C	3651 000 0072
					35RSC	Rapid Super C	3622 000 0072
<b>SOLO</b>							
633, 635, 636, 637, 642	30/12	3/8"	1,3	45	63PMC3	Picco Micro C3	3636 000 0040
635, 636, 637, 642	35/14	3/8"	1,3	52	63PMC	Picco Micro C	3613 000 0040
					63PD3	Picco Duro	3612 000 0040
					63PMC3	Picco Micro C3	3636 000 0052
614, 620	40/16	3/8"	1,3	57	63PMC	Picco Micro C	3613 000 0052
					63PD3	Picco Duro	3612 000 0052
					63PMC3	Picco Micro C3	3636 000 0057
639, 643 IP, 644, 645, 646, 650, 651, 652, 656, 656 SP	33/13	.325"	1,5	56	63PMC	Picco Micro C	3613 000 0057
					63PD3	Picco Duro	3612 000 0057
					25RMC	Rapid Micro C	3628 000 0056
639, 643 IP, 644, 645, 646, 650, 651, 651 SP, 652, 656, 656 SP	38/15	.325"	1,5	64	25RMC3	Rapid Micro C3	3633 000 0056
					25RSC	Rapid Super C	3638 000 0056
					25RMC	Rapid Micro C	3628 000 0064
656, 662, 665, 675, 681, 684	40/16	3/8"	1,5	60	25RMC3	Rapid Micro C3	3633 000 0064
					25RSC	Rapid Super C	3638 000 0064
					35RMC	Rapid Micro C	3651 000 0060
656, 662, 665, 675, 681, 684	45/18	3/8"	1,5	68	35RSC	Rapid Super C	3622 000 0060
					35RMC	Rapid Micro C	3651 000 0068
					35RSC	Rapid Super C	3622 000 0068

Модель	Длина	Шаг	Паз	Кол-во звеньев	Цепь	Полное название	Артикул
639, 645, 646, 650, 651, 651 SP, 652, 656, 656 SP	45/18	.325"	1,5	72	25RMC	Rapid Micro C	3628 000 0072
					25RMC3	Rapid Micro C3	3633 000 0072
					25RSC	Rapid Super C	3638 000 0072
656, 662, 665, 675, 681, 684, 694	50/20	3/8"	1,5	72	35RMC	Rapid Micro C	3651 000 0072
					35RSC	Rapid Super C	3622 000 0072
656, 662, 665, 675, 681, 684, 694	60/24	3/8"	1,5	84	35RMC	Rapid Micro C	3651 000 0084
					35RSC	Rapid Super C	3622 000 0084
656, 662, 665, 675, 681, 684, 694	70/28	3/8"	1,5	92	35RMC	Rapid Micro C	3651 000 0092
					35RSC	Rapid Super C	3622 000 0092
690, 694	60/24	.404"	1,6	76	46RM	Rapid Micro	3668 000 0076
					46RS	Rapid Super	3946 000 0076
					46RSK	Rapid Super K	3846 000 0076
					46RCK	Rapid Standard K	3812 000 0076
690, 694	70/28	.404"	1,6	84	46RM	Rapid Micro	3668 000 0084
					46RS	Rapid Super	3946 000 0084
					46RSK	Rapid Super K	3846 000 0084
					46RCK	Rapid Standard K	3812 000 0084
<b>STIGA</b>							
SPR 270 C	25/10	1/4"	1,3	60	13RMC	Rapid Micro C	3660 000 0060
					13RMS	Rapid Micro Spezial	3661 000 0060
SPR 270	25/10	3/8"	1,3	40	63PMC3	Picco Micro C3	3636 000 0040
					63PMC	Picco Micro C	3613 000 0040
					63PD3	Picco Duro	3612 000 0040
SPR 280	30/12	3/8"	1,3	45	63PMC3	Picco Micro C3	3636 000 0045
					63PMC	Picco Micro C	3613 000 0045
					63PD3	Picco Duro	3612 000 0045
SP 402, SP 420, SP 422, SP 442, SP 472	33/13	.325"	1,3	56	23RMC	Rapid Micro C	3627 000 0056
					23RMC3	Rapid Micro C3	3632 000 0056
					23RSC	Rapid Super C	3637 000 0056
SE 170, SE 170Q, SE 182, SE 182Q, SE 190, SE 192, SE 202, SE 202Q, SP 350, SP 382	35/14	3/8"	1,3	52	63PMC3	Picco Micro C3	3636 000 0052
					63PMC	Picco Micro C	3613 000 0052
					63PD3	Picco Duro	3612 000 0052
SP 420, SP 422, SP 442, SP 472	40/16	.325"	1,3	66	23RMC	Rapid Micro C	3627 000 0066
					23RMC3	Rapid Micro C3	3632 000 0066
					23RSC	Rapid Super C	3637 000 0066
SE 200, SE 200Q, SP 350, SP 382, SP 400	40/16	3/8"	1,3	57	63PMC3	Picco Micro C3	3636 000 0057
					63PMC	Picco Micro C	3613 000 0057
					63PD3	Picco Duro	3612 000 0057
SP 420, SP 422, SP 442, SP 472	45/18	.325"	1,3	72	23RMC	Rapid Micro C	3627 000 0072
					23RMC3	Rapid Micro C3	3632 000 0072
					23RSC	Rapid Super C	3637 000 0072
SP 400	45/18	3/8"	1,3	62	63PMC3	Picco Micro C3	3636 000 0062
					63PMC	Picco Micro C	3613 000 0062
					63PD3	Picco Duro	3612 000 0062
SP 472, SP 482, SP 522	33/13	.325"	1,5	56	25RMC	Rapid Micro C	3628 000 0056
					25RMC3	Rapid Micro C3	3633 000 0056
					25RSC	Rapid Super C	3638 000 0056

# Пильные цепи для моторных пил других марок

Модель	Длина	Шаг	Паз	Кол-во звеньев	Цепь	Полное название	Артикул
SP 472, SP 522	40/16	.325"	1,5	66	25RMC	Rapid Micro C	3628 000 0066
					25RMC3	Rapid Micro C3	3633 000 0066
					25RSC	Rapid Super C	3638 000 0066
SP 472, SP 482, SP 522	45/18	.325"	1,5	72	25RMC	Rapid Micro C	3628 000 0072
					25RMC3	Rapid Micro C3	3633 000 0072
					25RSC	Rapid Super C	3638 000 0072
SP 680	45/18	3/8"	1,5	68	35RMC	Rapid Micro C	3651 000 0068
SP 680	50/20	3/8"	1,5	72	35RSC	Rapid Super C	3622 000 0068
					35RMC	Rapid Micro C	3651 000 0072
35RSC					35RSC	Rapid Super C	3622 000 0072
<b>STURM</b>							
GC99374	35/14	3/8"	1,3	52	63PMC3	Picco Micro C3	3636 000 0052
					63PMC	Picco Micro C	3613 000 0052
					63PD3	Picco Duro	3612 000 0052
					63PMC3	Picco Micro C3	3636 000 0057
CC9920, CC9922, GC99376, GC99386, GC99416, GC99456, GC99466	40/16	3/8"	1,3	57	63PMC	Picco Micro C	3613 000 0057
					63PD3	Picco Duro	3612 000 0057
					63PMC3	Picco Micro C3	3636 000 0062
CC9942, GC99418, GC99458, GC99468	45/18	3/8"	1,3	62	63PMC	Picco Micro C	3613 000 0062
					63PD3	Picco Duro	3612 000 0062
<b>SUNGARDEN</b>							
SCS 1800, БОБР 3614	35/14	3/8"	1,3	52	63PMC3	Picco Micro C3	3636 000 0052
					63PMC	Picco Micro C	3613 000 0052
					63PD3	Picco Duro	3612 000 0052
					63PMC3	Picco Micro C3	3636 000 0057
SCS 2000, SCS 2200, БОБР 3816, БОБР 4118	40/16	3/8"	1,3	57	63PMC	Picco Micro C	3613 000 0057
					63PD3	Picco Duro	3612 000 0057
					25RMC	Rapid Micro C	3628 000 0066
БОБР 4116	40/16	.325"	1,5	66	25RMC3	Rapid Micro C3	3633 000 0066
					25RSC	Rapid Super C	3638 000 0066
					25RMC	Rapid Micro C	3628 000 0072
					25RMC3	Rapid Micro C3	3633 000 0072
БОБР 4518	45/18	.325"	1,5	72	25RSC	Rapid Super C	3638 000 0072
					25RMC	Rapid Micro C	3628 000 0078
					25RMC3	Rapid Micro C3	3633 000 0078
					25RSC	Rapid Super C	3638 000 0078
БОБР 5020	50/20	.325"	1,5	78	35RMC	Rapid Micro C	3651 000 0078
					35RSC	Rapid Super C	3622 000 0078
БОБР 6222	55/22	3/8"	1,5	78			
<b>ZENOAH KOMATSU</b>							
G2500	25/10	1/4"	1,3	60	13RMC	Rapid Micro C	3660 000 0060
					13RMS	Rapid Micro Spezial	3661 000 0060
					63PMC3	Picco Micro C3	3636 000 0040
					63PMC	Picco Micro C	3613 000 0040
G2500	25/10	3/8"	1,3	40	63PD3	Picco Duro	3612 000 0040
					63PMC3	Picco Micro C3	3636 000 0045
					63PMC	Picco Micro C	3613 000 0045
					63PD3	Picco Duro	3612 000 0045
G3200	30/12	3/8"	1,3	45			

Модель	Длина	Шаг	Паз	Кол-во звеньев	Цепь	Полное название	Артикул
G3200, G3300EZ, G3800	35/14	3/8"	1,3	52	63PMC3	Picco Micro C3	3636 000 0052
					63PMC	Picco Micro C	3613 000 0052
					63PD3	Picco Duro	3612 000 0052
GZ4000	35/14	.325"	1,3	60	23RMC	Rapid Micro C	3627 000 0060
					23RMC3	Rapid Micro C3	3632 000 0060
					23RSC	Rapid Super C	3637 000 0060
GZ4000	40/16	.325"	1,3	66	23RMC	Rapid Micro C	3627 000 0066
					23RMC3	Rapid Micro C3	3632 000 0066
					23RSC	Rapid Super C	3637 000 0066
G3800	40/16	3/8"	1,3	57	63PMC3	Picco Micro C3	3636 000 0057
					63PMC	Picco Micro C	3613 000 0057
					63PD3	Picco Duro	3612 000 0057
G455, G500	35/14	.325"	1,5	60	25RMC	Rapid Micro C	3628 000 0060
					25RMC3	Rapid Micro C3	3633 000 0060
					25RSC	Rapid Super C	3638 000 0060
G455, G500	40/16	.325"	1,5	66	25RMC	Rapid Micro C	3628 000 0066
					25RMC3	Rapid Micro C3	3633 000 0066
					25RSC	Rapid Super C	3638 000 0066
G621	40/16	3/8"	1,5	60	35RMC	Rapid Micro C	3651 000 0060
					35RSC	Rapid Super C	3622 000 0060
					25RMC	Rapid Micro C	3628 000 0072
G455, G500	45/18	.325"	1,5	72	25RMC3	Rapid Micro C3	3633 000 0072
					25RSC	Rapid Super C	3638 000 0072
					35RMC	Rapid Micro C	3651 000 0066
G621	45/18	3/8"	1,5	66	35RSC	Rapid Super C	3622 000 0066
					35RMC	Rapid Micro C	3651 000 0072
G621	50/20	3/8"	1,5	72	35RSC	Rapid Super C	3622 000 0072
					35RMC	Rapid Micro C	3651 000 0084
G621	60/24	3/8"	1,5	84	35RSC	Rapid Super C	3622 000 0084
					35RMC	Rapid Micro C	3651 000 0084
<b>ИНТЕРСКОЛ</b>							
ПЦБ-14/35Л	35/14	3/8"	1,3	52	63PMC3	Picco Micro C3	3636 000 0052
					63PMC	Picco Micro C	3613 000 0052
					63PD3	Picco Duro	3612 000 0052
ПЦБ-16/38Л, ПЦ-16/2000Тн, ПЦ-400	40/16	3/8"	1,3	57	63PMC3	Picco Micro C3	3636 000 0057
					63PMC	Picco Micro C	3613 000 0057
					63PD3	Picco Duro	3612 000 0057
<b>КАЛИБР</b>							
БП-1300, ЭПЦ-2000 ПД, ЭПЦ-2200 ПД, ЭПЦ-2400 ПД	40/16	3/8"	1,3	57	63PMC3	Picco Micro C3	3636 000 0057
					63PMC	Picco Micro C	3613 000 0057
					63PD3	Picco Duro	3612 000 0057
БП-1700, БП-2100, ЭПЦ-2000, ЭПЦ-2200, ЭПЦ-2400	45/18	3/8"	1,3	62	63PMC3	Picco Micro C3	3636 000 0062
					63PMC	Picco Micro C	3613 000 0062
					63PD3	Picco Duro	3612 000 0062
<b>Зид</b>							
Тайга-245	40/16	3/8"	1,5	64	35RMC	Rapid Micro C	3651 000 0064
					35RSC	Rapid Super C	3622 000 0064
УРАЛ 2Т, УРАЛ-70, Дружба-4М	46	.404"	1,6	64	46RM	Rapid Micro	3668 000 0064

# Пильные цепи для моторных пил других марок

Модель	Длина	Шаг	Паз	Кол-во звеньев	Цепь	Полное название	Артикул
					46RS	Rapid Super	3946 000 0064
					46RSK	Rapid Super K	3846 000 0064
					46RCK	Rapid Standard K	3812 000 0064
					46RMF	Rapid Micro Fullskip	3671 000 0064
					46RMK	Rapid Micro Klassik	3860 000 0064
					46RSF	Rapid Super Fullskip	3911 000 0064

## ЭНЕРГОМАШ

ПТ-99374	35/14	3/8"	1,3	52	63PMC3	Picco Micro C3	3636 000 0052
					63PMC	Picco Micro C	3613 000 0052
					63PD3	Picco Duro	3612 000 0052
ПЦ-99200, ПЦ-99220, ПТ-99386	40/16	3/8"	1,3	57	63PMC3	Picco Micro C3	3636 000 0057
					63PMC	Picco Micro C	3613 000 0057
					63PD3	Picco Duro	3612 000 0057

### Специальная маркировка



На режущих зубьях цепей STIHL нанесена специальная маркировка, указывающая на границу заточки в верхней части и предельную границу износа в нижней части зуба

### Швейцарское качество

Original **STIHL**<sup>®</sup>  
Swiss Made



Все цепи STIHL делаются на собственном заводе компании в городе Виль (Швейцария). Современные технологии и оборудование гарантируют швейцарское качество пильных цепей





# Направляющие шины для моторных пил STIHL



## Условные обозначения:

Длина реза	Шаг цепи	Толщина ведущего звена	Ограничитель глубины реза – Расстояние	Режущий зуб (справа)	Режущий зуб (слева)	Соединительное звено без заклепки	Соединительное звено с заклепки	Правое 3-бугорчатое соединительное звено
Правое 3-бугорчатое соединительное звено	Ведущее звено	Бугорчатое ведущее звено	Тип цепи	Цепь в бухте	Длина цепь в бухте	Круглый напильник	Диаметр напильника	Держатель с круглым напильником
Направляющая шина Ematic ROLLOMATIC E (стандарт)	Направляющая шина Ematic ROLLOMATIC ES (супер)	Направляющая шина Ematic DUROMATIC	Ширина паза	Шаг концевой звездочки	Число зубьев концевой звездочки			
Концевая звездочка/вершина шины	Заклепка с потайной головкой	Профильное цепное колесо	Кольцевое цепное колесо (комплект)	Кольцевое цепное колесо (запасное)	Шаг цепного колеса	Число зубьев цепного колеса		

# Направляющие шины для моторных пил STIHL

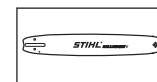
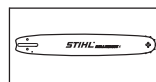
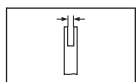
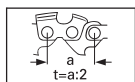
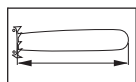

Модель	cm	in	mm	in	mm	in	Rollomatic E	Rollomatic E	
STIHL 017, 018,	25	140	9.32	3/8 P	1.1	.043	39	3005 008 7603 <sup>4</sup>	7
MS 170,	30	12	9.32	3/8 P	1.1	.043	44	3005 000 3905 <sup>1</sup>	7
MS 180,	35	14	9.32	3/8 P	1.1	.043	50	3005 008 3909 <sup>1</sup>	7
MS 171,	40	16	9.32	3/8 P	1.1	.043	55	3005 008 3913 <sup>1</sup>	7
MS 181	30	12	9.32	3/8 P	1.3	.050	44	3005 000 4805	9
	35	14	9.32	3/8 P	1.3	.050	50	3005 000 4809	9
STIHL 019 T,	30	12	9.32	3/8 P	1.1	.043	44	3005 000 3905 <sup>1</sup>	7
MS 190 T	35	14	9.32	3/8 P	1.1	.043	50	3005 008 3909 <sup>1</sup>	7
	40	16	9.32	3/8 P	1.1	.043	55	3005 008 3913 <sup>1</sup>	7
	30	12	9.32	3/8 P	1.3	.050	44	3005 000 4805	9
	35	14	9.32	3/8 P	1.3	.050	50	3005 000 4809	9
	40	16	9.32	3/8 P	1.3	.050	55	3005 008 4813	9
STIHL MS 192 T,	25	10	9.32	3/8 P	1.1	.043	39	3005 008 7603 <sup>4</sup>	7
MS 192 C	30	12	9.32	3/8 P	1.1	.043	44	3005 000 3905 <sup>1</sup>	7
	35	14	9.32	3/8 P	1.1	.043	50	3005 008 3909 <sup>1</sup>	7
	30	12	9.32	3/8 P	1.3	.050	43	3005 000 4805	9
	35	14	9.32	3/8 P	1.3	.050	50	3005 000 4809	9
	40	16	9.32	3/8 P	1.3	.050	55	3005 008 4813	9
	45	18	9.32	3/8 P	1.3	.050	61	3005 000 4817	9
STIHL 020 (1129),	30	12	9.32	3/8 P	1.3	.050	44	3005 000 4805	9
STIHL 020 T,	35	14	9.32	3/8 P	1.3	.050	50	3005 000 4809	9
MS 200,	40	16	9.32	3/8 P	1.3	.050	55	3005 008 4813	9
MS 200 T	45	18	9.32	3/8 P	1.3	.050	61	3005 000 4817	9
(020, MS 200)	40	16	8.25	.325	1.6	.063	62	3005 008 4713	11
	45	18	8.25	.325	1.6	.063	68	3005 008 4717	11
STIHL 021, 023, 025,	30	12	9.32	3/8 P	1.3	.050	44	3005 000 4805	9
MS 210	35	14	9.32	3/8 P	1.3	.050	50	3005 000 4809	9
MS 230	40	16	9.32	3/8 P	1.3	.050	55	3005 008 4813	9
MS 250	45	18	9.32	3/8 P	1.3	.050	61	3005 008 4817	9
MS 211	35	14	9.32	3/8 P	1.3	.050	51 <sup>5</sup>	3005 000 4809	9
(025, MS 250)	40	16	9.32	3/8 P	1.3	.050	56 <sup>5</sup>	3005 008 4813	9
	45	18	9.32	3/8 P	1.3	.050	62 <sup>5</sup>	3005 000 4817	9
(023 L),	30	12	9.32	3/8 P	1.1	.043	44	3005 000 3905 <sup>1</sup>	7
(MS 230),	35	14	9.32	3/8 P	1.1	.043	50	3005 008 3909 <sup>1</sup>	7
(023 L),	40	16	9.32	3/8 P	1.1	.043	55	3005 008 3913 <sup>1</sup>	7
(023 L),	35	14	8.25	.325	1.5	.058	56	3005 000 5009	11
	35	14	8.25	.325	1.5	.058	56	3005 000 5009	11
	40	16	8.25	.325	1.6	.063	62	3005 008 4713	11
(025, MS 250)	45	18	8.25	.325	1.6	.063	68	3005 008 4717	11

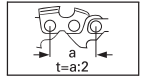
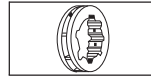
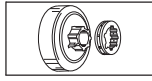
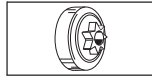
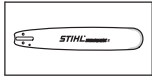
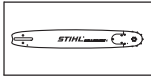

Rollomatic ES		Duromatic				mm	in
		1123 640 2003	6			9.32	3/8 P
		1123 640 2003	6			9.32	3/8 P
		1123 640 2003	6			9.32	3/8 P
		1137 640 2003	6			9.32	3/8 P
		1123 640 2003	6			9.32	3/8 P
		1137 640 2001	6			9.32	3/8 P
		1137 640 2001	6			9.32	3/8 P
		1129 640 2000	6			9.32	3/8 P
		1123 640 2073	6			9.32	3/8 P
		1123 640 2072	7	1123 007 1030	7	0000 642 1240	7 9.32 3/8 P
		1123 640 2073	6			9.32	3/8 P
		1123 640 2072	7	1123 007 1030	7	0000 642 1240	7 9.32 3/8 P
		1123 640 2073	6			9.32	3/8 P
		1123 640 2074	7	1123 007 1032	7	0000 642 1236	7 8.25 .325
		1123 640 2076	8	1123 007 1031	8	0000 642 1234	8 8.25 .325
		1123 640 2076	8	1123 007 1031		0000 642 1234	8 8.25 .325

# Направляющие шины для моторных пил STIHL

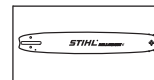
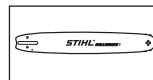
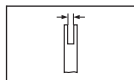
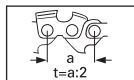
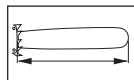

Модель	cm	in	mm	in	mm	in	Rollomatic E	Rollomatic E			
STIHL 026, MS 260	32	13	8.25	.325	1.5	.058	56	3003 000 5006	11		
	37	15	8.25	.325	1.5	.058	62 <sup>3</sup>	3003 000 5011	11		
	32	13	8.25	.325	1.6	.063	56	3003 000 5306	11		
	37	15	8.25	.325	1.6	.063	62 <sup>3</sup>	3003 000 6811	11		
	40	16	8.25	.325	1.6	.063	67	3003 000 6813	11		
	45	18	8.25	.325	1.6	.063	74	3003 008 6817	11		
	32	13	9.32	3/8 P	1.3	0.50	50	3003 000 6306	9		
	40	16	9.32	3/8 P	1.3	0.50	60	3003 000 6313	9		
	45	18	9.32	3/8 P	1.3	0.50	66	3003 000 6317	9		
	32	13	9.32	3/8	1.6	.063	50	3003 000 6106	10		
	37	15	9.32	3/8	1.6	.063	56	3003 000 6111	10	3003 000 5211	11
	40	16	9.32	3/8	1.6	.063	60	3003 000 6113	10	3003 000 5213	11
45	18	9.32	3/8	1.6	.063	66	3005 000 6117	10	3003 000 5217	11	
STIHL MS 261, MS 261 C-Q	32	13	8.25	.325	1.5	.058	56	3003 000 5006	11		
	37	15	8.25	.325	1.5	.058	62 <sup>3</sup>	3003 000 5011	11		
	32	13	8.25	.325	1.6	.063	56	3003 000 5306	11		
	37	15	8.25	.325	1.6	.063	62 <sup>3</sup>	3003 000 6811	11		
	40	16	8.25	.325	1.6	.063	67	3003 000 6813	11		
	45	18	8.25	.325	1.6	.063	74	3003 008 6817	11		
STIHL MS 270, MS 270 C, MS 280 MS 280 C	32	13	8.25	.325	1.5	.058	56	3003 000 5006	11		
	37	15	8.25	.325	1.5	.058	62 <sup>3</sup>	3003 000 5011	11		
	32	13	8.25	.325	1.6	.063	56	3003 000 5306	11		
	37	15	8.25	.325	1.6	.063	62 <sup>3</sup>	3003 000 6811	11		
	40	16	8.25	.325	1.6	.063	67	3003 000 6813	11		
	45	18	8.25	.325	1.6	.063	74	3003 008 6817	11		
	32	13	9.32	3/8	1.6	.063	50	3003 000 6106	10		
	37	15	9.32	3/8	1.6	.063	56	3003 000 6111	10	3003 000 5211	11
	40	16	9.32	3/8	1.6	.063	60	3003 000 6113	10	3003 000 5213	11
	45	18	9.32	3/8	1.6	.063	66	3005 008 6117	10	3003 000 5217	11
STIHL 029, 039 MS 290, MS 310' MS 390	32	13	8.25	.325	1.5	.058	56	3003 000 5006	11		
	37	15	8.25	.325	1.5	.058	62 <sup>3</sup>	3003 000 5011	11		
	32	13	8.25	.325	1.6	.063	56	3003 000 5306	11		
	37	15	8.25	.325	1.6	.063	62 <sup>3</sup>	3003 000 6811	11		
	40	16	8.25	.325	1.6	.063	67	3003 000 6813	11		
	45	18	8.25	.325	1.6	.063	74	3003 008 6817	11		
	50	20	8.25	.325	1.6	.063	81	3003 008 6821	11		
	32	13	9.32	3/8	1.6	.063	50	3003 000 6106	10		
	37	15	9.32	3/8	1.6	.063	56	3003 000 6111	10	3003 000 5211	11
	40	16	9.32	3/8	1.6	.063	60	3003 000 6113	10	3003 000 5213	11
	45	18	9.32	3/8	1.6	.063	66	3003 008 6117	10	3003 000 5217	11
	50	20	9.32	3/8	1.6	.063	72	3003 008 6121	10	3003 000 5221	11
	50	20	9.32	3/8	1.6	.063	72				

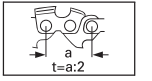
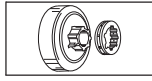
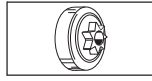
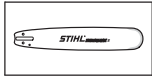
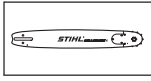

Rollomatic ES		Duromatic						mm	in
			1121 640 2004	7	1121 007 1037	7	0000 642 1236	7	8.25 .325
			1121 640 2005	8	1121 007 1038	8	0000 642 1234	8	8.25 .325
			1121 640 2004	7	1121 007 1037	7	0000 642 1236	7	8.25 .325
		3003 000 9211	1121 640 2005	8	1121 007 1038	8	0000 642 1234	8	8.25 .325
		3003 000 9213							
		3003 000 9217							
					1121 007 1039	7	0000 642 1240	7	9.32 3/8 P
		3003 000 8613			1121 007 1040	8	0000 642 1241	8	9.32 3/8 P
		3003 000 8617							
					1121 007 1041	7	0000 642 1231	7	9.32 3/8
		303 000 9211							
3003 000 9413	11	3003 000 9213							
3003 000 9417	11	3003 000 9217							
			1141 160 5416 <sup>5</sup>	7	1141 007 1002	7	0000 642 1236	7	8.25 .325
		3003 000 9211							
		3003 000 9213							
		3003 000 9217							
			1121 640 2004	7	1121 007 1037	7	0000 642 1236	7	8.25 .325
			1121 640 2005	8	1121 007 1038	8	0000 642 1234	8	8.25 .325
			1121 640 2004	7	1121 007 1037	7	0000 642 1236	7	8.25 .325
		3003 000 9211	1121 640 2005	8	1121 007 1038	8	0000 642 1234	8	8.25 .325
		3003 000 9213							
		3003 000 9217							
					1121 007 1041	7	0000 642 1231	7	9.32 3/8
		3003 000 9211							
3003 000 9413	11	3003 000 9213							
3003 000 9417	11	3003 000 9217							
			1125 640 2005	7	1125 007 1001	7	0000 642 1236	7	8.25 .325
			1125 640 2008	8	1125 007 1000	8	0000 642 1234	8	8.25 .325
			1125 640 2005	7	1125 007 1001	7	0000 642 1236	7	8.25 .325
		3003 000 9211	1125 640 2008	8	1125 007 1000	8	0000 642 1234	8	8.25 .325
		3003 000 9213							
		3003 000 9217							
		3003 000 9221							
			1125 640 2004	7	1125 007 1002	7	0000 642 1231	7	9.32 3/8
		3003 000 9211	1140 650 2000 <sup>2</sup>	7					
3003 000 9413	11	3003 000 9213							
3003 000 9417	11	3003 000 9217							
3003 000 9421	11	3003 000 9221							
3003 000 9821	13								

# Направляющие шины для моторных пил STIHL



Модель	cm	in	mm	in	mm	in		Rollomatic E	Rollomatic E		
STIHL 034, 036,	32	13	8.25	.325	1.5	.058	56	3003 000 5006	11		
MS 340,	37	15	8.25	.325	1.5	.058	62 <sup>3</sup>	3003 000 5011	11		
MS 360	32	13	8.25	.325	1.6	.063	56	3003 000 5306	11		
	37	15	8.25	.325	1.6	.063	62 <sup>3</sup>	3003 000 6811	11		
	40	16	8.25	.325	1.6	.063	67	3003 000 6813	11		
	45	18	8.25	.325	1.6	.063	74	3003 008 6817	11		
	50	20	8.25	.325	1.6	.063	81	3003 008 6821	11		
	32	13	9.32	3/8	1.6	.063	50	3003 000 6106	10		
	37	15	9.32	3/8	1.6	.063	56	3003 000 6111	10	3003 000 5211	11
	40	16	9.32	3/8	1.6	.063	60	3003 000 6113	10	3003 000 5213	11
	45	18	9.32	3/8	1.6	.063	66	3003 008 6117	10	3003 000 5217	11
	50	20	9.32	3/8	1.6	.063	72	3003 008 6121	10	3003 000 5221	11
	50	20	9.32	3/8	1.6	.063	72				

STIHL MS 341,	32	13	8.25	.325	1.5	.058	57	3003 000 5006	11		
MS 361,	37	15	8.25	.325	1.5	.058	64	3003 000 5011	11		
MS 362	32	13	8.25	.325	1.6	.063	57	3003 000 5306	11		
	37	15	8.25	.325	1.6	.063	64	3003 000 6811	11		
	40	16	8.25	.325	1.6	.063	68	3003 000 6813	11		
	45	18	8.25	.325	1.6	.063	75	3003 008 6817	11		
	50	20	8.25	.325	1.6	.063	82	3003 008 6821	11		
	32	13	9.32	3/8	1.6	.063	50	3003 000 6106	10		
	37	15	9.32	3/8	1.6	.063	56	3003 000 6111	10	3003 000 5211	11
	40	16	9.32	3/8	1.6	.063	60	3003 000 6113	10	3003 000 5213	11
	45	18	9.32	3/8	1.6	.063	66	3003 008 6117	10	3003 000 5217	11
	50	20	9.32	3/8	1.6	.063	72	3003 008 6121	10	3003 000 5221	11
	50	20	9.32	3/8	1.6	.063	72				

STIHL 044, 046	37	15	8.25	.325	1.6	.063	64	3003 000 6811	11
MS 440,	40	16	8.25	.325	1.6	.063	68	3003 000 6813	11
MS 441,	45	18	8.25	.325	1.6	.063	75	3005 008 6817	11
MS 360,	50	20	8.25	.325	1.6	.063	82	3003 008 6821	
	40	16	9.32	3/8	1.6	.063	60	3003 000 5213	11
	45	18	9.32	3/8	1.6	.063	66	3003 000 5217	11
	50	20	9.32	3/8	1.6	.063	72	3003 000 5221	11
	50	20	9.32	3/8	1.6	.063	72		
	50	20	9.32	3/8	1.6	.063	72		
	63	25	9.32	3/8	1.6	.063	84	3003 008 5231	11
	75	30	9.32	3/8	1.6	.063	98		
	90	36	9.32	3/8	1.6	.063	114		

MS 441 C-Q									
MS 460 R	50	20	9.32	3/8	1.6	.063	72		

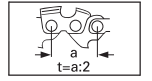
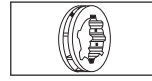
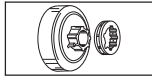
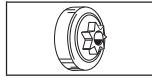
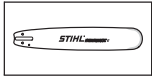
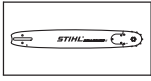

Rollomatic ES		Duromatic						mm	in
			1125 640 2005	7	1125 007 1001	7	0000 642 1236	7	8.25 .325
					1125 007 1000	8	0000 642 1234	8	8.25 .325
			1125 640 2005	7	1125 007 1001	7	0000 642 1236	7	8.25 .325
			3003 000 9211		1125 007 1000	8	0000 642 1234	8	8.25 .325
			3003 000 9213						
			3003 000 9217						
			3003 000 9221						
			1125 640 2006	7	1125 007 1041	7	0000 642 1223	7	9.32 3/8
			3003 000 9211						
3003 000 9413	11		3003 000 9213						
3003 000 9417	11		3003 000 9217						
3003 000 9421	11		3003 000 9221						
3003 000 9821	13								
					1128 007 1011	9	0000 642 1239	9	8.25 .325
			3003 000 9211		1128 007 1011	9	0000 642 1239	9	8.25 .325
			3003 000 9213						
			3003 000 9217						
			3003 000 9221						
			1128 640 2000	7	1128 007 1000	7	0000 642 1223	7	9.32 3/8
			3003 000 9211		1128 007 1001	8	0000 642 1216	8	9.32 3/8
3003 000 9413	11		3003 000 9213						
3003 000 9417	11		3003 000 9217						
3003 000 9421	11		3003 000 9221						
3003 000 9821	13								
			3003 000 9211		1128 007 1011	9	0000 642 1239	9	8.25 .325
			3003 000 9213						
			3003 000 9217						
			3003 000 9221						
3003 000 9413	11		3003 000 9213	1128 640 2005	8	1128 007 1001	8	0000 642 1216	8 9.32 3/8
3003 000 9417	11		3003 000 9217						
3003 000 9421	11		3003 000 9221						
3003 002 9421	11								
3003 000 9821	13								
3003 000 9831	13		3003 000 5631						
3003 000 9842	13								
3003 000 9853	13								
					1138 160 5450	7	0000 642 1223	7	
3003 002 9421	11								

# Направляющие шины для моторных пил STIHL



Модель	cm	in	mm	in	mm	in	Rollomatic E	Rollomatic E	
STIHL 064, 066	40	16	9.32	3/8	1.6	.063	60	3003 000 5213	11
MS 640,	45	18	9.32	3/8	1.6	.063	66	3003 000 5217	11
MS 650,	50	20	9.32	3/8	1.6	.063	72	3003 000 5221	11
MS 660	50	20	9.32	3/8	1.6	.063	72		
	63	25	9.32	3/8	1.6	.063	84	3003 000 5231	11
	75	30	9.32	3/8	1.6	.063	98		
	90	36	9.32	3/8	1.6	.063	114	3003 000 2053 <sup>1</sup>	11
	90	36	10.26	.404	1.6	.063	104		

064, 066,	45	18	9.32	3/8 P	1.3	.050	66	3003 000 6317	9	
MS 640,	50	20	9.32	3/8 P	1.3	.050	72			
MS 660,	63	25	9.32	3/8 P	1.3	.050	84			
LOGOSOL	45	18	9.32	3/8	1.6	.063	66		3003 000 5217	11
	50	20	9.32	3/8	1.6	.063	72		3003 000 5221	11
	50	20	9.32	3/8	1.6	.063	72			
	63	25	9.32	3/8	1.6	.063	84		3003 000 5231	11

STIHL MS 780,	53	21	9.32	3/8	1.6	.063	75			
084, 088,	63	25	9.32	3/8	1.6	.063	88			
MS 880	90	36	10.26	.404	1.6	.063	108			
	150	59	10.26	.404	1.6	.063	173			

STIHL 070, 090,										
MS 720										
(090)	150	59	10.26	.404	1.6	.063	173			

STIHL E 140, E 160,	35	14	9.32	3/8 P	1.3	.050	50	3005 000 4809	9	3005 000 7409 <sup>2</sup>	9
E 180,	40	16	9.32	3/8 P	1.3	.050	55	3002 008 4813			
MSE 140, 140 C	45	18	9.32	3/8 P	1.3	.050	61	3002 000 4817	9		
MSE 160, 160 C	35	14	9.32	3/8 P	1.3	.050	51 <sup>5</sup>	3005 000 4809	9	3005 000 7409 <sup>2</sup>	9
MSE 180, 180 C	40	16	9.32	3/8 P	1.3	.050	56 <sup>5</sup>	3005 008 4813	9		
MSE 200, 200 C	45	18	9.32	3/8 P	1.3	.050	62 <sup>5</sup>	3003 000 4817	9		
(E 160, E 180,	45	18	9.32	3/8 P	1.3	.050	61				
MSE 160											
MSE 180											
MSE 200)											
(MSE 140)	30	12	9.32	3/8 P	1.1	.043	44	3005 000 3905 <sup>1</sup>		3005 000 7605 <sup>6</sup>	7
(E 140)	35	14	9.32	3/8 P	1.1	.043	50	3005 000 3909 <sup>1</sup>		3005 000 7609 <sup>6</sup>	7
(E 140)	40	16	9.32	3/8 P	1.1	.043	55	3005 000 3913 <sup>1</sup>			

STIHL E 20, E 220,	37	15	8.25	.325	1.6	.063	63	3003 000 6811			
MSE 220	40	16	8.25	.325	1.6	.063	67	3003 000 6813			
	45	16	8.25	.325	1.6	.063	74	3003 008 6817			
	50	20	8.25	.325	1.6	.063	81	3003 008 6821			



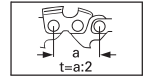
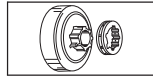
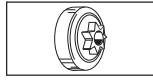
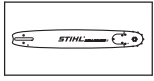

Rollomatic ES		Duromatic						mm	in
3003 000 9413	11	3003 000 9213	1122 640 2002	7	1122 007 1000	7	0000 642 1223	7	9.32 3/8
3003 000 9417	11	3003 000 9217	1122 640 2000	8	1122 007 1001	8	0000 642 1216	8	9.32 3/8
3003 000 9421	11	3003 000 9221							
3003 000 9821	13								
3003 000 9831	13	3003 000 5631							
3003 000 9842	13								
3003 000 9853	13								
	10	3003 000 8453							

			1122 640 2006	7					9.32 3/8 P
		3003 000 8621							
		3003 000 5531							
3003 000 9417	11	3003 000 9217	1122 640 2002	7	1122 007 1000	7	0000 642 1223	7	9.32 3/8
3003 000 9421	11	3003 000 9221	1122 640 2000	8	1122 007 1001	8	0000 642 1216	8	9.32 3/8
3003 000 9821	13								
3003 000 9831	13	3003 000 5631							
		3002 000 8423	1124 640 2004	8	1124 007 1025	8	0000 642 1216	8	9.32 3/8
		3003 000 9231							
3002 000 9753	12								
3002 000 9576	12								

3002 000 9576	12								



			1206 642 1301	7					9.32 3/8 P

		3003 000 9211	1207 640 2051	8					8.25 .325
		3003 000 9213							
		3003 000 9217							
		3003 000 9221							

# Направляющие шины для моторных пил STIHL

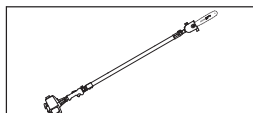

Модель	cm	in	mm	in	mm	in		Rollomatic E	Rollomatic E
STIHL E 20, E 220, MSE 220	37	16	9.32	3/8	1.6	.063	57	3003 000 6111	10
	40	16	9.32	3/8	1.6	.063	60	3003 000 6113	10
	45	18	9.32	3/8	1.6	.063	66	3003 000 6117	10
	50	20	9.32	3/8	1.6	.063	72	3003 000 6121	10



STIHL HT 70, HT 75, HT 100, HT 130, HT, HT-KM, HTE 60, HT 101, HT 131	30	12	9.32	3/8 P	1.1	.043	44	3005 000 3905 <sup>1</sup>	
	30	12	9.32	3/8 P	1.1	.043	44	3005 000 3905 <sup>1</sup>	



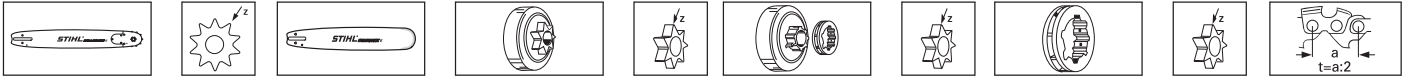

Rollomatic ES		Duromatic		mm	in
		3003 000 9211	1207 640 2050	8	9.32 3/8
3003 000 9413	11	3003 000 9213			
3003 000 9417	11	3003 000 9217			
3003 000 9421	11	3003 000 9221			

		4138 642 1250	6	9.32	3/8 P
		4138 642 1350	7		
		4138 642 1201	6		
		4138 642 1350	7		



# Комплекующие к пильным цепям STIHL

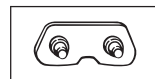
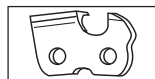
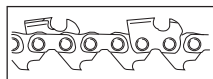
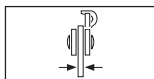
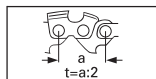

mm	in	mm	in						
6,35	1/4	1,3	.050	3660	13 RMC	3660 007 1000 <sup>1</sup>	3660 007 1001 <sup>2</sup>	3660 660 7200	3660 662 5000
6.35	1.4	1.3	.050	3661	13 RMS	3661 007 1000 <sup>1</sup>	3661 007 1001 <sup>2</sup>	3660 660 7200	3660 662 5000
8.25	.325	1.3	.050	3627	23 RMC	3629 007 1000 <sup>1</sup>	3629 007 1001 <sup>2</sup>	3629 660 7200	3629 662 4200
8.25	.325	1.3	.050	3632	23 RMC3	3629 007 1000 <sup>1</sup>	3629 007 1001 <sup>2</sup>	3629 660 7200	3629 662 4200
8.25	.325	1.3	.050	3637	23 RSC	3639 007 1000 <sup>1</sup>	3639 007 1001 <sup>2</sup>	3629 660 7200	3629 662 4200
8.25	.325	1.5	.058	3628	25 RMC	3629 007 1000 <sup>1</sup>	3629 007 1001 <sup>2</sup>	3629 660 7200	3629 662 4200
8.25	.325	1.5	.058	3633	25 RMC3	3629 007 1000 <sup>1</sup>	3629 007 1001 <sup>2</sup>	3629 660 7200	3629 662 4200
8.25	.325	1.5	.058	3638	25 RSC	3639 007 1000 <sup>1</sup>	3639 007 1001 <sup>2</sup>	3629 660 7200	3629 662 4200
8.25	.325	1.6	.063	3629	26 RMC	3629 007 1000 <sup>1</sup>	3629 007 1001 <sup>2</sup>	3629 660 7200	3629 662 4200
8.25	.325	1.6	.063	3634	26 RMC3	3629 007 1000 <sup>1</sup>	3629 007 1001 <sup>2</sup>	3629 660 7200	3629 662 4200
8.25	.325	1.6	.063	3638	26 RSC	3639 007 1000 <sup>1</sup>	3639 007 1001 <sup>2</sup>	3629 660 7200	3629 662 4200
9.32	3/8 P	1.3	.050	3612	63 PD3	3612 007 1000 <sup>1</sup>	3612 007 1001 <sup>2</sup>	3997 660 6600	3997 662 1200
9.32	3/8 P	1.3	.050	3636	63 PMC3	3636 007 1000 <sup>1</sup>	3636 007 1001 <sup>2</sup>	3997 660 6600	3997 662 1200
9.32	3/8 P	1.3	.050	3613	63 PMC	3636 007 1000 <sup>1</sup>	3636 007 1001 <sup>2</sup>	3997 660 6600	3997 662 1200
9.32	3/8 P	1.3	.050	3614	63 PMX	3614 007 1000 <sup>1</sup>	3614 007 1001 <sup>2</sup>	3997 660 6600	3997 662 1200
9.32	3/8 P	1.3	.050	3615	63 PMY	3636 007 1000 <sup>1</sup>	3636 007 1001 <sup>2</sup>	3997 660 6600	3997 662 1200
9.32	3/8 P	1.1	.050	3610	61 PMMC3	3610 007 1000 <sup>1</sup>	3610 007 1001 <sup>2</sup>	3610 660 7200	3610 662 5000
9.32	3/8	1.3	.050	3650	33 RMC	3652 007 1000 <sup>1</sup>	3652 007 1001 <sup>2</sup>	3724 660 6600	3718 662 1200
9.32	3/8	1.3	.050	3662	33 RMC3	3652 007 1000 <sup>1</sup>	3652 007 1001 <sup>2</sup>	3724 660 6600	3718 662 1200
9.32	3/8	1.3	.050	3993	33 RMF	3991 662 0400	3991 662 0600	3724 660 6600	3718 662 1200
9.32	3/8	1.3	.050	3623	33 RSC	3621 007 1000 <sup>1</sup>	3621 007 1001 <sup>2</sup>	3724 660 6600	3718 662 1200
9.32	3/8	1.3	.050	3624	33 RSC3	3621 007 1000 <sup>1</sup>	3621 007 1001 <sup>2</sup>	3724 660 6600	3718 662 1200
9.32	3/8	1.3	.050	3874	33 RSK	3868 662 0400	3868 662 0600	3724 660 6600	3718 662 1200
9.32	3/8	1.3	.050	3953	33 RSF	3881 662 0400	3881 662 0600	3724 660 6600	3718 662 1200
9.32	3/8	1.3	.050	3645	33 RSLHK	3640 662 0400	3640 662 0600	3724 660 6600	3718 662 1200
9.32	3/8	1.3	.050	3640	33 RSLK	3640 662 0400	3640 662 0600	3724 660 6600	3718 662 1200
9.32	3/8	1.3	.050	3948	33 RD	3943 660 6300	3943 660 6500	3724 660 6600	3718 662 1200
9.32	3/8	1.5	.058	3651	35 RMC	3652 007 1000 <sup>1</sup>	3652 007 1001 <sup>2</sup>	3724 660 6600	3718 662 1200
9.32	3/8	1.5	.058	3622	35 RSC	3621 007 1000 <sup>1</sup>	3621 007 1001 <sup>2</sup>	3724 660 6600	3718 662 1200
9.32	3/8	1.5	.058	3913	35 RSF	3881 662 0400	3881 662 0600	3724 660 6600	3718 662 1200
9.32	3/8	1.6	.063	3653	36 RMX	3653 007 1000 <sup>1</sup>	3653 007 1001 <sup>2</sup>	3724 660 6600	3718 662 1200
9.32	3/8	1.6	.063	3652	36 RMC	3652 007 1000 <sup>1</sup>	3652 007 1001 <sup>2</sup>	3724 660 6600	3718 662 1200
9.32	3/8	1.6	.063	3664	36 RMC3	3652 007 1000 <sup>1</sup>	3652 007 1001 <sup>2</sup>	3724 660 6600	3718 662 1200
9.32	3/8	1.6	.063	3621	36 RSC	3621 007 1000 <sup>1</sup>	3621 007 1001 <sup>2</sup>	3724 660 6600	3718 662 1200
9.32	3/8	1.6	.063	3626	36 RSC3	3621 007 1000 <sup>1</sup>	3621 007 1001 <sup>2</sup>	3724 660 6600	3718 662 1200
9.32	3/8	1.6	.063	3898	36 RSK	3868 662 0400	3868 662 0600	3724 660 6600	3718 662 1200



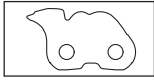
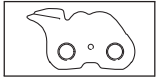

3731 662 1001			
3731 662 1001			
3862 662 1000			
3862 662 1000	3632 662 1100		
3862 662 1000			
3863 662 1000			
3863 662 1000	3632 662 1100		
3863 662 1000			
3603 662 1000			
3603 662 1000	3634 662 1100		
3603 662 1000			
3997 662 1000	3636 662 1100		
3997 662 1000	3636 662 1100		
3997 662 1000		TI 40.2008	
3997 662 1000		TI 40.2008	
3997 662 1000		TI 40.2008	
3997 662 1000	3610 662 1100	TI 31.2007	
3833 662 1000			
3833 662 1000	3624 662 1100		
3833 662 1000			
3833 662 1000			
3833 662 1000	3624 662 1100		
3833 662 1000			
3833 662 1000			
3833 662 1000			
3833 662 1000			
3833 662 1000			
3833 662 1000			
3833 662 1000			
3844 662 1000			
3844 662 1000			
3844 662 1000			
3725 662 1000		TI 03.2008	
3725 662 1000			
3725 662 1000	3626 662 1100		
3725 662 1000			
3725 662 1000	3626 662 1100		
3725 662 1000			

# Комплектующие к пильным цепям STIHL



mm	in	mm	in						
9.32	3/8	1.6	.063	3648	36 RSLHK	3640 662 0400	3640 662 0600	3724 660 6800	3718 662 1200
9.32	3/8	1.6	.063	3641	36 RSLK	3640 662 0400	3640 662 0600	3724 660 6800	3718 662 1200
9.32	3/8	1.6	.063	3954	36 RSLF	3954 662 0400	3954 662 0600	3724 660 6800	3718 662 1200
9.32	3/8	1.6	.063	3644	36 RSLFK	3640 662 0400	3640 662 0600	3724 660 6800	3718 662 1200
9.32	3/8	1.6	.063	3943	36 RD	3943 660 6300	3943 660 6500	3724 660 6800	3718 662 1200
9.32	3/8	1.6	.063	3944	36 RDR	3944 660 6300	3944 660 6500	3724 660 6800	3718 662 1200
10.26	.404	1.5	.063	3924	45 RSF	3946 662 0400	3846 662 0600	3712 660 6601	3712 662 1202
10.26	.404	1.6	.063	3812	46 RC	3812 662 0401	3812 662 0601	3712 660 6601	3712 662 1202
10.26	.404	1.6	.063	3958	46 RCX	3958 662 0400	3958 662 0600	3712 660 6601	3712 662 1202
10.26	.404	1.6	.063	3895	46 RCX	3895 662 0400	3895 662 0600	3712 660 6601	3712 662 1202
10.26	.404	1.6	.063	3668	46 RM	3668 007 1000 <sup>1</sup>	3668 007 1001 <sup>2</sup>	3712 660 6601	3712 662 1202
10.26	.404	1.6	.063	3860	46 RMK	3860 662 0400	3860 662 0600	3712 660 6601	3712 662 1202
10.26	.404	1.6	.063	3838	46 RMX	3838 662 0400	3881 662 0600	3712 660 6601	3712 662 1202
10.26	.404	1.6	.063	3671	46 RMF	3668 007 1000 <sup>1</sup>	3668 007 1001 <sup>2</sup>	3712 660 6601	3712 662 1202
10.26	.404	1.6	.063	3946	46 RS	3946 662 0400	3646 662 0600	3712 660 6601	3712 662 1202
10.26	.404	1.6	.063	3846	46 RSK	3846 662 0400	3846 662 0600	3712 660 6601	3712 662 1202
10.26	.404	1.6	.063	3911	46 RSF	3946 662 0400	3877 662 0600	3712 660 6601	3712 662 1202
10.26	.404	1.6	.063	3851	46 RSLF	3877 662 0400	3877 662 0600	3712 660 6601	3712 662 1202

Пильные цепи STIHL – это трехзвеньевые пильные цепи, сконструированные всегда по одному и тому же принципу. Они различаются между собой лишь профилем режущих зубьев (тип цепи) и размерами отдельных звеньев цепи (шаг и толщина ведущих звеньев).

На нижеследующей иллюстрации изображены отдельные детали пильной цепи Oilomatic.

Ведущее звено (1), левый режущий зуб (2), правый режущий зуб (3), соединительное звено с закатанными заклепками (4), соединительное звено (5), бугорчатое ведущее звено (6), трехбугорчатое соединительное звено (7).

Средний ряд звеньев состоит из одинаковых звеньев цепи, ведущих звеньев (1). Приводная мощность двигателя посредством ведущих звеньев передается от цепной звездочки на пильную цепь. Одновременно ведущие звенья, движущиеся в пазу шины, направляют пильную цепь сбоку на направляющей шине. Передняя боковая сторона ведущих звеньев в направлении движения закруглена и служит одновременно в качестве пазового пространства.

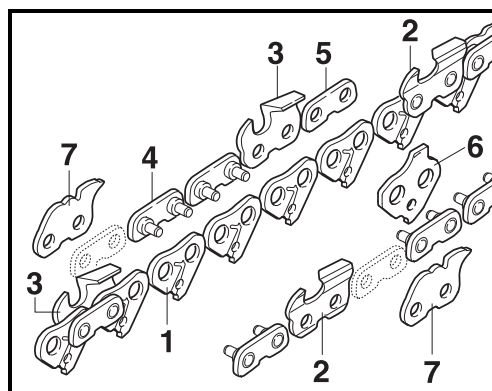

Оба внешних ряда зубьев состоят из расположенных попеременно режущих зубьев (2, 3) и соединительных звеньев (4, 5). Режущие зубья (2, 3) являются, собственно говоря, рабочими элементами пильной цепи. Форма и состояние лезвий оказывают решающее влияние на результат резания. На противоположной стороне режущих зубьев и во впадинах между режущими зубьями расположены соединительные звенья (4, 5). Соединительные звенья и режущие зубья образуют совместно плоскость

1 = 5x + 5x 2 = 5x + 5x



# Комплектующие к направляющим шинам STIHL

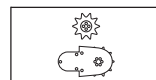
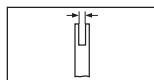
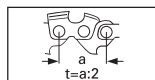
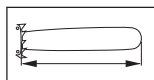

	cm	in	mm	in	mm	in			
3003 000 5006	32	13	8.25	.325	1.5	.058	3003 650 9927	11	0000 974 0420
3003 000 5011	37	15	8.25	.325	1.5	.058	3003 650 9927	11	0000 974 0420
3003 000 5306	32	13	8.25	.325	1.6	.063	3003 650 9926	11	0000 974 0420
3003 000 6811	37	15	8.25	.325	1.6	.063	3003 650 9926	11	0000 974 0420
3003 000 6813	40	16	8.25	.325	1.6	.063	3003 650 9926	11	0000 974 0420
3003 008 6817	45	18	8.25	.325	1.6	.063	3003 650 9926	11	0000 974 0420
3005 000 5009	35	14	8.25	.325	1.5	.058	3003 650 9927	11	0000 974 0420
3005 008 4713	40	16	8.25	.325	1.6	.063	3003 650 9926	11	0000 974 0420
3005 008 4717	45	18	8.25	.325	1.6	.063	3003 650 9926	11	0000 974 0420
3003 000 6306	32	13	9.32	3/8 P	1.3	.050	3005 650 9903	9	0000 974 0421
3003 000 6313	40	16	9.32	3/8 P	1.3	.050	3005 650 9903	9	0000 974 0421
3003 000 6317	45	18	9.32	3/8 P	1.3	.050	3005 650 9903	9	0000 974 0421
3005 000 4805	30	12	9.32	3/8 P	1.3	.050	3005 650 9903	9	0000 974 0421
3005 000 4809	35	14	9.32	3/8 P	1.3	.050	3005 650 9903	9	0000 974 0421
3005 000 7409	35	14	9.32	3/8 P	1.3	.050	3005 650 9903	9	0000 974 0421
3005 008 4813	40	16	9.32	3/8 P	1.3	.050	3005 650 9903	9	0000 974 0421
3005 000 4817	45	18	9.32	3/8 P	1.3	.050	3005 650 9903	9	0000 974 0421
3003 000 8921	50	20	9.32	3/8	1.3	.050	3003 650 9928	10	0000 974 0420
3003 000 6106	32	13	9.32	3/8	1.6	.063	3005 650 9922	10	0000 974 0420
3003 000 6111	37	15	9.32	3/8	1.6	.063	3005 650 9922	10	0000 974 0420
3003 000 6113	40	16	9.32	3/8	1.6	.063	3005 650 9922	10	0000 974 0420
3003 008 6117	45	18	9.32	3/8	1.6	.063	3005 650 9922	10	0000 974 0420
3003 008 6121	50	20	9.32	3/8	1.6	.063	3005 650 9922	10	0000 974 0420
3003 000 5213	40	16	9.32	3/8	1.6	.063	3003 650 9935	11	0000 974 0420
3003 000 5217	45	18	9.32	3/8	1.6	.063	3003 650 9935	11	0000 974 0420
3003 000 5221	50	20	9.32	3/8	1.6	.063	3003 650 9935	11	0000 974 0420
3003 000 5231	63	25	9.32	3/8	1.6	.063	3003 650 9935	11	0000 974 0420
3003 000 9417	45	18	9.32	3/8	1.6	.063	3003 650 2551*	11	0000 974 0503
3003 000 9421	50	20	9.32	3/8	1.6	.063	3003 650 2551*	11	0000 974 0503
3003 000 8853	90	36	9.32	3/8	1.6	.058	3003 650 2551*	11	0000 974 0503
3003 000 6053	90	36	9.32	3/8	1.6	.063	3003 650 2551*	11	0000 974 0503
3003 000 9821	50	20	9.32	3/8	1.6	.063	3003 650 2539*	13	0000 974 0503
3003 000 9831	63	25	9.32	3/8	1.6	.050	3003 650 2539*	13	0000 974 0503
3003 000 9842	75	30	9.32	3/8	1.6	.050	3003 650 2539*	13	0000 974 0503
3003 000 9853	90	36	9.32	3/8	1.6	.063	3003 650 2539*	13	0000 974 0503
3002 000 9753	90	36	10.26	.404	1.6	.063	3003 650 2538*	12	0000 974 0503
3002 000 9576	150	41	10.26	.404	1.6	.063	3003 650 2538*	12	0000 974 0503











7028 871 0010

© ООО «Андреас Штиль Маркетинг»

Отпечатано в России. 2011 г.

8-800-4444-180

[www.stihl.ru](http://www.stihl.ru)